

# ***Nikon***

En

The ***Nikon*** Guide to Digital Photography  
with the

# **COOLPIX 2500**

**DIGITAL CAMERA**

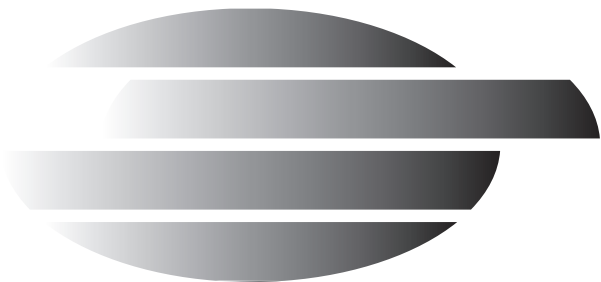



**COOLPIX 2500 (En)**



# Shoot, View, and Enjoy

A Flowchart Guide to Using Your Camera



## STEP 1—Ready the camera

Getting ready	▶ First Steps	 16
Camera setup	▶ First Steps ▶ Camera Setup	 16 69





## STEP 2—Take pictures

Snapshots (auto mode)	▶ Tutorial: Taking Pictures	 24
Creative photography (scene mode)	▶ Getting Creative	 36
Custom shots and movies	▶ Taking Pictures: The Details	 51

## STEP 3—Play them back...

...while shooting...	▶ Review and Deletion	 31
...after shooting...	▶ Basic Playback	 78

### ...and delete unwanted pictures...

...immediately	▶ Keep or Delete	 58
...while shooting	▶ Review and Deletion	 31
...during playback	▶ Basic Playback	 78
Delete multiple pictures	▶ Deleting Pictures	 86

## STEP 4—Install camera software

Install software	▶ <i>Quick Start Guide</i> (provided)	—
Get to know Nikon View 5	▶ <i>Nikon View 5 Reference Manual</i> (provided on CD)	—

## STEP 5—Copy pictures to your computer

Transfer pictures	▶ Connections	 41
-------------------	---------------	--

# Product Documentation

The documentation for this product includes the manuals listed below. Please be sure to read all instructions thoroughly to get the most from your camera.

## ***Quick-Start Guide***

The *Quick-Start Guide* takes you through the process of unpacking and setting up your Nikon digital camera, taking your first pictures, installing software, and transferring pictures to your computer.

## ***Guide to Digital Photography***

The *Guide to Digital Photography* (this manual) provides complete operating instructions for your camera.

## ***Nikon View 5 Reference Manual***

The *Nikon View 5 Reference Manual* can be found in electronic format on the reference CD provided with your camera. For information on viewing the *Reference Manual*, see “Connections” in this manual.

Overview



Getting to Know the COOLPIX 2500



Menu Guide



First Steps



Taking Pictures



Review and Deletion



Getting Creative



Connections



Beyond Point-and-Shoot



Fine-Tuning Camera Settings



Camera Setup



Basic Playback



The Playback Menu



Technical Notes



Index



# For Your Safety

To prevent damage to your Nikon product or injury to yourself or to others, read the following safety precautions in their entirety before using this equipment. Keep these safety instructions where all those who use the product will read them.

The consequences that could result from failure to observe the precautions listed in this section are indicated by the following symbol:



This icon marks warnings, information that should be read before using your Nikon product to prevent possible injury.

## WARNINGS



### **Turn off immediately in the event of malfunction**

Should you notice smoke or an unusual smell coming from the equipment or from the AC adapter (available separately), unplug the AC adapter or remove the battery immediately, taking care to avoid burns. Continued operation could result in injury. After removing the battery, take the equipment to a Nikon-authorized service center for inspection.



### **Do not use in the presence of flammable gas**

Do not use electronic equipment in the presence of flammable gas, as this could result in explosion or fire.



### **Observe caution when using the camera strap**

Caution should be exercised to prevent strangulation when wearing the camera strap around your neck. Never place the strap around the neck of an infant or child.



### **Do not disassemble**

Touching the product's internal parts could result in injury. In the event of a malfunction, the product should be repaired only by a qualified technician. Should the product break open as the result of a fall or other accident, remove the battery or AC adapter and then take the product to a Nikon-authorized service center for inspection.



### **Observe proper precautions when handling batteries**

Batteries may leak or explode if improperly handled. Observe the following precautions when handling batteries for use in this product:

- Be sure the product is off before replacing the battery. If you are using an AC adapter, be sure it is unplugged.
- Use only a rechargeable Nikon EN-EL2 lithium-ion battery (supplied).
- When inserting the battery, do not attempt to insert it upside down or backwards.
- Do not short or disassemble the battery.
- Do not expose the battery to flame or to excessive heat.
- Do not immerse in or expose to water.
- Do not transport or store with metal objects such as necklaces or hairpins.

- Batteries are prone to leakage when fully discharged. To avoid damage to the product, be sure to remove the battery when no charge remains.
- When the battery is not in use, attach the terminal cover and store in a cool place.
- Immediately after use, or when the product is used on battery power for an extended period, the battery may become hot. Before removing the battery, turn the camera off and allow the battery to cool.
- Discontinue use immediately should you notice any changes in the battery, such as discoloration or deformation.

#### **Use appropriate cables**

When connecting cables to the input and output jacks, use only the cables provided or sold by Nikon for the purpose, to maintain compliance with product regulations.

#### **The lens section**

- Do not insert your fingers in the gap between the rotating lens section and the camera body. Your fingers could be pinched between the body and the lens section, resulting in injury. Particular care should be observed in the case of small children.
- To prevent your fingers, flesh, or other objects from being pinched in the gap between the rotating lens section and the camera body, return the lens section to its housing in the camera body before transporting the camera.

#### **Keep out of reach of children**

Particular care should be taken to prevent infants from putting the battery or other small parts into their mouths.

#### **Removing memory cards**

Memory cards may become hot during use. Observe due caution when removing memory cards from the camera.

#### **CD-ROMs**

The CD-ROMs on which the software and manuals are distributed should not be played back on audio CD equipment. Playing CD-ROMs on an audio CD player could cause hearing loss or damage the equipment.

#### **Observe caution when operating the flash**

Using the flash close to your subject's eyes could cause temporary visual impairment. Particular care should be observed if photographing infants, when the flash should be no less than one meter (39") from the subject.

#### **Avoid contact with liquid crystal**

Should the monitor break, care should be taken to avoid injury due to broken glass and to prevent liquid crystal from the monitor touching the skin or entering the eyes or mouth.

# Caring for the Camera and Battery

## Keep dry

This product is not waterproof, and may malfunction if immersed in water or exposed to high levels of humidity. Rusting of the internal mechanism can cause irreparable damage.

## Keep free of salt, sand, and dust

After using your camera at the beach or seaside, wipe off any sand or salt with a lightly dampened cloth and then dry your camera thoroughly.

## Do not touch the lens with your fingers

The proper procedure for cleaning the lens is described in "Technical Notes: Caring for Your Camera."

## Handle the lens and all moving parts with care

Do not apply force to the lens or to the battery, card, and connector covers. These parts are especially susceptible to damage.

## Turn the product off before removing the battery or unplugging the AC adapter

Do not unplug the product or remove the battery while the product is on, or while images are being recorded or deleted. Forcibly cutting power to the product in these circumstances could result in loss of data or in damage to product memory or internal circuitry. To prevent an accidental interruption of power, avoid carrying the product from one location to another while the AC adapter is connected.

## Do not drop

The product may malfunction if subjected to strong shocks or vibration.

## Keep away from strong magnetic fields

Do not use or store this device in the vicinity of equipment that generates strong electromagnetic radiation or magnetic fields. Strong static charges or the magnetic fields produced by equipment such as radio transmitters could interfere with the monitor, damage data stored on the memory card, or affect the product's internal circuitry.

## Avoid sudden changes in temperature

Sudden changes in temperature, such as occur when entering or leaving a heated building on a cold day, can cause condensation inside the device. To prevent condensation, place the device in a carrying case or a plastic bag before exposing it to sudden changes in temperature.

## Notes on the monitor

- The monitor may contain a few pixels that are always lit or that do not light. This is a characteristic common to all TFT LCD monitors and does not indicate a malfunction. Images recorded with the product will not be affected.
- Images in the monitor may be difficult to see in a bright light.
- The monitor is lit by an LED backlight. Should the monitor begin to dim or flicker, contact your Nikon service representative.
- Do not apply pressure to the monitor, as this could cause damage or malfunction. Dust or lint adhering to the monitor can be removed with a blower brush. Stains can be removed by rubbing the surface lightly with a soft cloth or chamois leather.
- Should the monitor break, care should be taken to avoid injury due to broken glass and to prevent the liquid crystal from the monitor touching the skin or entering the eyes or mouth.

## Smear

When you frame bright subjects, vertical comet-like streaks that whiten toward either end may appear in the monitor. This phenomenon, known as “smear,” does not appear in the final photograph and does not indicate a malfunction. Some smearing may appear in movies.

## Batteries

- When you turn the device on, check the battery-level displayed in the monitor to determine whether the battery needs to be replaced. The battery needs to be replaced when the battery-level indicator is flashing.
- Ready a spare battery and keep it fully charged when taking pictures on important occasions. Depending on your location, you may find it difficult to purchase replacement batteries on short notice.
- On cold days, the capacity of batteries tends to decrease. Be sure the battery is fully charged before taking pictures outside in cold weather. Keep a spare battery in a warm place and exchange the two as necessary. Once warmed, a cold battery may recover some of its charge.
- Should the battery terminals become dirty, wipe them off with a clean, dry cloth before use.

## Memory cards

- Turn the power off before inserting or removing memory cards. Inserting or removing cards with the power on could render them unusable.
- Insert memory cards as shown in the illustration at right. Inserting cards upside down or backwards could damage the camera or the card.

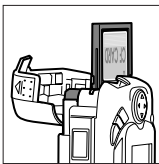

## Storage

- To prevent mold or mildew, store the camera in a dry, well-ventilated area. If you will not be using the product for long periods, remove the battery to prevent leakage and store the camera in a plastic bag containing a desiccant. Do not, however, store the camera case in a plastic bag, as this may cause the material to deteriorate. Note that desiccant gradually loses its capacity to absorb moisture and should be replaced at regular intervals.
- Do not store the camera with naphtha or camphor moth balls, close to equipment that produces strong magnetic fields, or in areas subject to extremes of temperature, for example near a space heater or in a closed vehicle on a hot day.
- To prevent mold or mildew, take the camera out of storage at least once a month. Turn the camera on and release the shutter a few times before putting the camera away again.
- Store the battery in a cool, dry place.

# Notices

- No part of the manuals included with this product may be reproduced, transmitted, transcribed, stored in a retrieval system, or translated into any language in any form, by any means, without Nikon's prior written permission.
- Nikon reserves the right to change the specifications of the hardware and software described in these manuals at any time and without prior notice.
- Nikon will not be held liable for any damages resulting from the use of this product.
- While every effort has been made to ensure that the information in these manuals is accurate and complete, we would appreciate it were you to bring any errors or omissions to the attention of the Nikon representative in your area (address provided separately).

## Notice for customers in Canada

### CAUTION

This class B digital apparatus meets all requirements of the Canadian Interference Causing Equipment Regulations.

### ATTENTION

Cet appareil numérique de la classe B respecte toutes les exigences du Règlement sur le matériel brouilleur du Canada.



---

### A Note on Electronically-Controlled Cameras

---

In extremely rare instances, unusual characters may appear in the monitor and the camera may stop functioning. In most cases, this phenomenon is caused by a strong external static charge. Turn the camera off, remove and replace the battery, and turn the camera on again, or, if you are using an AC adapter (available separately), disconnect and reconnect the adapter and turn the camera on again. In the event of continued malfunction, contact your retailer or Nikon representative. Note that disconnecting the power source as described above may result in loss of any data not recorded to the memory card at the time the problem occurred. Data already recorded to the memory card will not be affected.



## Notice for customers in the U.S.A.

### *Federal Communications Commission (FCC) Radio Frequency Interference Statement*

This equipment has been tested and found to comply with the limits for a Class B digital device, pursuant to Part 15 of the FCC rules. These limits are designed to provide reasonable protection

against harmful interference in a residential installation. This equipment generates, uses, and can radiate radio frequency energy and, if not installed and used in accordance with the instructions, may cause harmful interference to radio communications. However, there is no guarantee that interference will not occur in a particular installation. If this equipment does cause harmful interference to radio or television reception, which can be determined by turning the equipment off and on, the user is encouraged to try to correct the interference by one or more of the following measures:

- Reorient or relocate the receiving antenna.
- Increase the separation between the equipment and receiver.
- Connect the equipment into an outlet on a circuit different from that to which the receiver is connected.
- Consult the dealer or an experienced radio/television technician for help.

## CAUTIONS

### *Modifications*

The FCC requires the user to be notified that any changes or modifications made to this device that are not expressly approved by Nikon Corporation may void the user's authority to operate the equipment.

### *Interface Cables*

Use the interface cables sold or provided by Nikon for your equipment. Using other interface cables may exceed the limits of Class B Part 15 of the FCC rules.

Nikon Inc.,  
1300 Walt Whitman Road, Melville, New York  
11747-3064, U.S.A.  
Tel.: 631-547-4200

**Nikon**

E2500



Tested To Comply  
With FCC Standards  
FOR HOME OR OFFICE USE

## Notice Concerning Prohibition of Copying or Reproduction

Note that simply being in possession of material that has been digitally copied or reproduced by means of a scanner, digital camera or other device may be punishable by law.



- **Items prohibited by law from being copied or reproduced**  
Do not copy or reproduce paper money, coins, securities, government bonds, or local government bonds, even if such copies or reproductions are stamped "Sample."  
The copying or reproduction of paper money, coins, or securities which are circulated in a foreign country is prohibited. Unless the prior permission of the government has been obtained, the copying or reproduction of unused postage stamps or post cards issued by the government is prohibited.  
The copying or reproduction of stamps issued by the government and of certified documents stipulated by law is prohibited.
- **Cautions on certain copies and reproductions**  
The government has issued cautions on copies or reproductions of securities issued by private companies (shares, bills, checks, gift certificates, etc.), commuter passes, or coupon tickets, except when a minimum of necessary copies are to be provided for business use by a company. Also, do not copy or reproduce passports issued by the government, licenses issued by public agencies and private groups, ID cards, and tickets, such as passes and meal coupons.
- **Comply with copyright notices**  
The copying or reproduction of copyrighted creative works such as books, music, paintings, woodcut prints, maps, drawings, movies, and photographs is prohibited except when it is done for personal use at home or for similar restricted and non-commercial use.

## Trademark Information

Apple, the Apple logo, Macintosh, Mac OS, Power Macintosh, PowerBook, and QuickTime are registered trademarks of Apple Computer, Inc. Finder, Power Mac, iMac, and iBook are trademarks of Apple Computer, Inc. IBM is a registered trademark of International Business Machines Corporation. Microsoft and Windows are registered trademarks of Microsoft Corporation. Internet is a trademark of Digital Equipment Corporation. CompactFlash is a trademark of SanDisk Corporation. Lexar Media is a trademark of Lexar Media Corporation. Adobe and Acrobat are registered trademarks of Adobe Systems Inc. Zip is a registered trademark of Iomega Corporation in the U.S. and other countries. All other trade names mentioned in this manual or the other documentation provided with your Nikon product are trademarks or registered trademarks of their respective holders.

# Table of Contents

Product Documentation .....	i
For Your Safety .....	ii
Caring for the Camera and Battery .....	iv
Notices .....	vi
<b>Introduction: Before You Begin .....</b>	<b>1</b>
Overview: About This Manual .....	2
Getting to Know the COOLPIX 2500: The Parts of the Camera and Their Functions .....	4
Where to Find It—Parts of the COOLPIX 2500 .....	4
How to Use It—Camera Controls and Displays .....	6
Menu Guide: Index to Menu Options .....	9
<b>Tutorial: Getting Started .....</b>	<b>15</b>
<b>First Steps: Getting Ready to Use Your Camera .....</b>	<b>16</b>
Step 1—Attach the Camera Strap .....	16
Step 2—Insert the Battery and Memory Card .....	16
Step 3—Check the Battery Level .....	18
Step 4—Choose a Language .....	20
Step 5—Set the Time and Date .....	22
<b>Taking Pictures: The Basics .....</b>	<b>24</b>
Step 1—Ready the Camera .....	24
Step 2—Choose  Mode .....	25
Step 3—Adjust Camera Settings (Optional) .....	26
Step 4—Frame the Picture .....	26
Step 5—Focus and Shoot .....	28
Step 6—Put the Camera Away .....	30
<b>Review and Deletion: Quick Review .....</b>	<b>31</b>
Quick Review .....	32
Full-Screen Review .....	32
Thumbnail Review .....	34
<b>Getting Creative: Scene Selection .....</b>	<b>36</b>
<b>Connections: Your Camera and Your Computer .....</b>	<b>41</b>
Before You Begin: Installing Nikon View 5 .....	42
Making the Connection: Connecting to Your Computer .....	44

<b>Taking Pictures: The Details</b> .....	<b>51</b>
Beyond Point-and-Shoot: Camera Controls .....	52
[A], [M], or Movie: Choosing a Shooting Mode .....	52
Flash Photography: The  Button .....	53
Delaying Shutter Release: Choosing a Self-Timer Mode .....	55
Framing Pictures: Optical and Digital Zoom .....	57
Keep or Delete: Picture Review .....	58
<b>Fine-Tuning Camera Settings: The -Mode Menu</b> .....	<b>59</b>
Making Effective Use of Memory: <i>Image Quality and Size</i> .....	60
Adjusting Exposure: <i>Exp. +/-</i> .....	63
Keeping Colors True: <i>White Balance</i> .....	64
Taking Pictures in a Sequence: <i>Continuous</i> .....	66
Getting Sharper Pictures: <i>BSS (Best Shot Selector)</i> .....	67
Making Edges More Distinct: <i>Image Sharpening</i> .....	68
<b>Camera Setup: The SET-UP Menu</b> .....	<b>69</b>
Adjusting Monitor Brightness: <i>Brightness</i> .....	72
Formatting Memory Cards: <i>CF Card Format</i> .....	72
Setting the Time and Date: <i>Date</i> .....	73
Conserving Battery Power: <i>Auto Off</i> .....	73
Choosing a Language: <i>Language</i> .....	74
Choosing a USB Protocol: <i>USB</i> .....	74
Restoring Default Settings: <i>Reset All</i> (  Mode Only) .....	76
<b>Playing Pictures Back: Playback Mode</b> .....	<b>77</b>
Basic Playback: Full-Frame and Thumbnail Playback .....	78
The Playback Menu: Managing Pictures .....	85
Deleting Pictures: <i>Delete</i> .....	86
Ordering Prints: <i>Print Set</i> .....	88
Safeguarding Valuable Pictures: <i>Protect</i> .....	90
Marking All Pictures for Transfer: <i>Auto Transfer</i> .....	91
<b>Technical Notes: Camera Care, Options, and Resources</b> .....	<b>93</b>
Caring for Your Camera .....	94
Optional Accessories .....	95
Web Resources .....	96
Troubleshooting .....	96
Specifications .....	103
<b>Index</b> .....	<b>106</b>

# Introduction

*Before You Begin*

This chapter is divided into the following sections:

## ***Overview***

Read this section for a description of how this manual is organized and for an explanation of the symbols and conventions used.

## ***Getting to Know the COOLPIX 2500***

Bookmark this section and refer to it as you read through the manual for information on the names and functions of camera parts.

## ***Menu Guide***

Refer to this section for instructions on using the menus that control some aspects of camera operation. This section also contains an index of menu options.

### Overview



2–3



### Getting to Know the COOLPIX 2500



4–8



### Menu Guide



9–14



Thank you for your purchase of a COOLPIX 2500 digital camera. This manual has been written to help you enjoy taking digital pictures with your COOLPIX 2500. Read this manual thoroughly before use, and keep it handy when using the product.

---

## Use Only Nikon Brand Electronic Accessories

---

Your Nikon COOLPIX digital camera is designed to the highest standards and includes complex electronic circuitry. Only Nikon brand electronic accessories (including battery chargers, batteries, and AC adapters) certified by Nikon specifically for use with your Nikon digital camera are engineered and proven to operate within the operational and safety requirements of this electronic circuitry.

THE USE OF NON-NIKON ELECTRONIC ACCESSORIES COULD DAMAGE YOUR CAMERA AND MAY VOID YOUR NIKON WARRANTY.

For more information about Nikon brand accessories, contact your local authorized Nikon dealer.

To make it easier to find the information you need, the following symbols and conventions are used:



This icon marks cautions, information that you should read before use to prevent damage to your camera.



This icon marks tips, additional information you may find helpful when using your camera.



This icon marks notes, information that you should read before using your camera.



This icon indicates that more information is available elsewhere in this manual.



## Life-Long Learning

As part of Nikon's "Life-Long Learning" commitment to ongoing product support and education, continually-updated information is available on-line at the following sites:

- For users in the U.S.A.: <http://www.nikonusa.com/>
- For users in Europe: <http://www.nikon-euro.com/>
- For users in Asia, Oceania, the Middle East, and Africa:  
<http://www.nikon-asia.com/>

Visit these sites to keep up-to-date with the latest product information, tips, answers to frequently-asked questions (FAQs), and general advice on digital imaging and photography. Additional information may be available from the Nikon representative in your area. See the URL below for contact information:  
<http://www.nikon-image.com/eng/>

# Getting to Know the COOLPIX 2500

*The Parts of the Camera and Their Functions*

Take a few moments to familiarize yourself with camera controls and displays.

You may find it helpful to bookmark this section and refer to it as you read through the rest of the manual.

## Where to Find It—Parts of the COOLPIX 2500

The parts of the camera are identified below. For more information on the function of each part, refer to the page numbers listed.

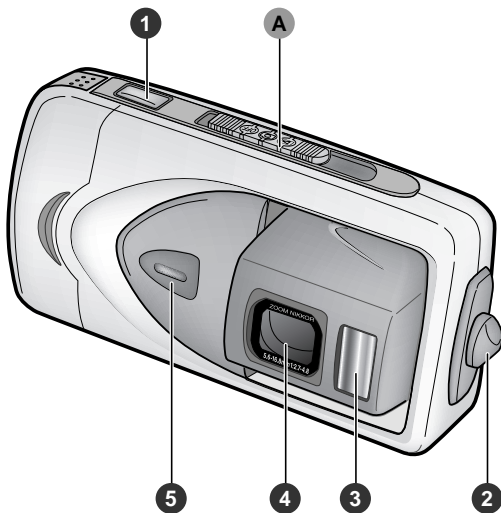

- |  |  |
|--|--|
| 1 Shutter-release button ..... 28, 29    | 8 Battery-chamber/memory card slot cover ..... 17                                    |
| 2 Eyelet for camera strap ..... 16       | 9 Cover release (for use when connecting optional EH-60 AC adapter kit) ..... 19, 95 |
| 3 Built-in Speedlight ..... 53           | 10 USB connector (under cover) ..... 45  |
| 4 Lens ..... 18, 26, 103                 | 11 QUICK  /SMALL PIC. button ... 31, 82  |
| 5 Self-timer lamp ..... 55               | 12  button ..... 59, 70, 85  |
| 6 Zoom buttons (/Q) ..... 27, 57, 80, 81 |  |
| 7 Cover latch ..... 17                   |  |



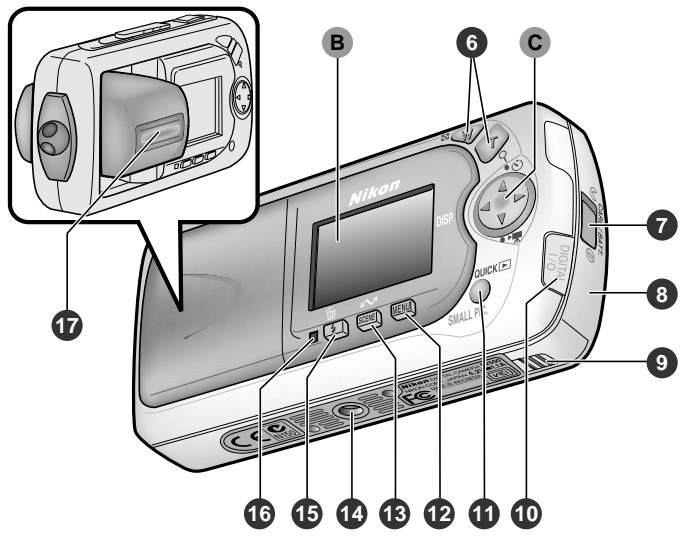





- |   |  |
|---|--|
| <p>13 <b>SCENE</b> /  button .. 36, 46, 79, 80</p> <p>14 Tripod socket</p> <p>15  /  button .... 33–34, 53, 78, 80</p> <p>16 Flash-ready lamp .....</p> <p>17 Non-slip grip</p> | <p><b>A</b> Mode selector .....</p> <p><b>B</b> Monitor .....</p> <p><b>C</b> Multi selector .....</p> |
|---|--|



## How to Use It—Camera Controls and Displays

### A The Mode Selector

The *mode selector* selects the operating mode and turns the camera on and off. Choose  to take still pictures and movies ( 52),  (playback mode) to play them back ( 78). Slide the mode selector to **OFF** when you have finished using the camera.

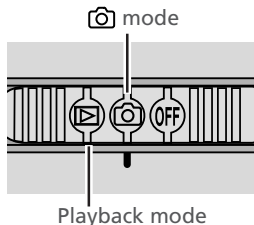

### B The Monitor

The *monitor* is where you compose pictures before shooting. In  mode, the monitor shows the view through the camera lens, together with icons indicating the status of camera settings.

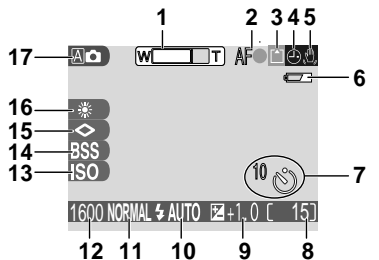

- 1 Zoom indicator ..... 57
- 2 Focus indicator<sup>1</sup> ..... 28
- 3 Recording indicator ..... 29
- 4 "Date not set" icon<sup>2</sup> ..... 23
- 5 Camera shake icon<sup>3</sup> ..... 54

- 6 Battery level indicator<sup>4</sup> ..... 19
- 7 Self-timer indicator ..... 55
- 8 Number of exposures remaining ..... 25
- 9 Exposure compensation ..... 63
- 10 Flash mode ..... 53
- 11 Image quality ..... 61
- 12 Image size ..... 62
- 13 Sensitivity gain indicator ..... 54
- 14 Best shot selector (BSS) ..... 67
- Continuous shooting mode ... 66
- 15 Image sharpening ..... 68
- 16 White balance ..... 64
- 17 Shooting mode ..... 25, 36

1 Displayed only when shutter-release button is pressed halfway.

2 Appears when clock-calendar has not been set.

3 Appears only at slow shutter speeds.

4 Appears only when battery is running low.

The monitor is also used to play pictures back. When a picture is played back full screen, information about the image is shown superimposed on the photo.

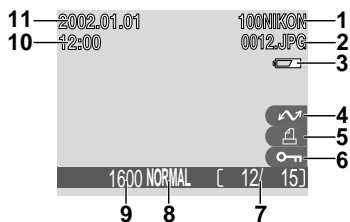

- 1 Current folder ..... 49
- 2 File number and type ..... 49
- 3 Battery level indicator\* ..... 19
- 4 Transfer icon ..... 33, 34, 44, 79
- 5 Print-order icon ..... 88
- 6 Protect icon ..... 90
- 7 Current frame number/  
total number of frames ... 32, 78
- 8 Image quality ..... 61
- 9 Image size ..... 62
- 10 Time of recording ..... 22
- 11 Date of recording ..... 22

\* Appears only when battery is running low.

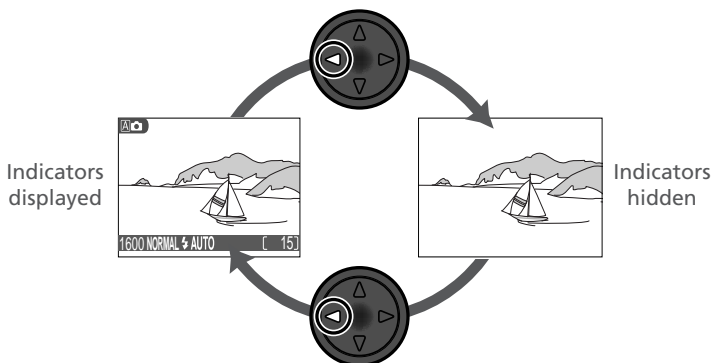

## Controlling the Monitor

To hide camera settings or photo info, press the multi selector to the left. Press the multi selector to the left a second time to view indicators again.





## C The Multi Selector

The *multi selector* is used to navigate through camera menus, to page through or select pictures during playback ( 78), and to control the display of indicators in the monitor. In  mode, the multi selector is also used to select the shooting mode and to turn the self-timer on and off.

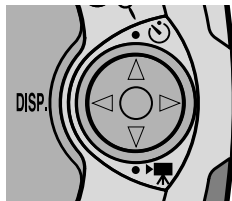

Self-timer on/off ( 55)



Press up to display self-timer menu, press up or down to highlight option. Press right to exit menu.

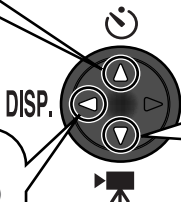

Indicators on/off ( 7)

Press to left to hide or display indicators in monitor.



Shooting mode selection ( 52)

















Press down to display shooting-mode menu, press up or down to highlight option. Press right to exit menu.

# Menu Guide

Index to Menu Options

Changes to some camera settings are made with the help of menus that appear in the camera monitor. The options available depend on the operating mode and, in  mode, on the shooting mode selected ( 52).

Mode	Menu	Description	
 	 SHOOTING	In  (auto) and scene modes, the SHOOTING menu is used to set image quality and size, and to adjust exposure for very bright, very dark, or high-contrast subjects.	10, 59– 63
 		 (manual) mode gives you full control over camera settings. In addition to the settings available in auto and scene modes, the manual-mode SHOOTING menu contains four advanced shooting options.	11, 59– 68
  	 SET-UP	The SET-UP menu, which is accessed from the SHOOTING menu, contains options for basic camera setup (e.g., setting the time and date, choosing a language).	12, 69– 76
	 PLAY BACK	The PLAY BACK menu contains options for managing the pictures stored on the memory card by, for example, deleting selected images or selecting pictures for printing or for transfer to your computer.	13, 71– 72, 85– 91

No menu is available in movie mode ( 52, 98).

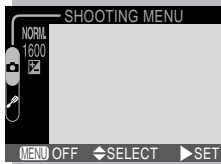

## The Shooting Menu

/ Scene

Pressing the MENU button when the mode selector is set to displays the SHOOTING menu. In (auto) and scene modes, this menu contains three basic shooting options.



### IMAGE QUALITY

Choose **FINE** for printing and enlarging, **BASIC** to reduce file size.



61

**FINE**

**NORMAL**

**BASIC**



### IMAGE SIZE

Choose small sizes for e-mail or the web, large sizes for printing.



62

**1600**

**1280**

**1024**

**640**



### EXP. +/-

Adjust exposure for bright, dark, or high contrast subjects.



63

Choose from settings between  $-2.0$  and  $+2.0$  EV



## The Shooting Menu M

In (manual) mode, the SHOOTING menu contains four advanced shooting options in addition to the three basic options available in auto and scene modes.



**IMAGE QUALITY**  
Choose **FINE** for printing and enlarging, **BASIC** to reduce file size.

- FINE
- NORMAL
- BASIC

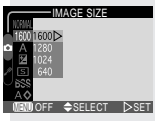

**IMAGE SIZE**  
Choose small sizes for e-mail or the web, large sizes for printing.

- 1600
- 1280
- 1024
- 640

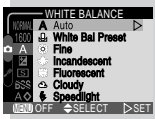

**WHITE BALANCE**  
Match to lighting to ensure that colors are reproduced accurately.

- A Auto
- White Bal Preset
- Fine
- Incandescent
- Fluorescent
- Cloudy
- Speedlight



**EXP. +/-**  
Adjust exposure for bright, dark, or high contrast subjects.

Choose from settings between  $-2.0$  and  $+2.0$  EV

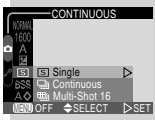

**CONTINUOUS**  
Take pictures in sequence or create collages of sixteen consecutive photographs.

- Single
- Continuous
- Multi-Shot 16

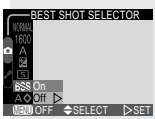

**BEST SHOT SELECTOR**  
Use when photos could be blurred by inadvertent camera movement.

- On
- Off

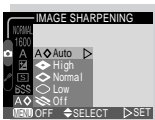

**IMAGE SHARPENING**  
Heighten or reduce the sharpness of outlines in your photographs.

- Auto
- High
- Normal
- Low
- Off

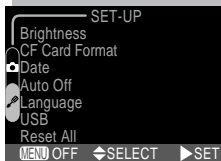

## The Setup Menu

/ / Scene

The SET-UP menu, which can be accessed from the SHOOTING menu, contains options for camera setup.



### Brightness

Adjust monitor brightness.

72

Maximum  
(Five levels)  
Minimum



### CF Card Format

Format memory cards for use in your camera.

72

No  
Format



### Date

Set the time and date.

22–23

Year, Month, Day, hour, minute, order of display for year, month, and day

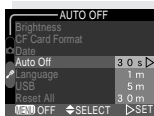

### Auto Off

Specify how long the monitor will remain on before turning off automatically to save power.

73

30 s  
1 m  
5 m  
30 m

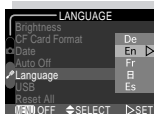

### Language

Choose the language in which camera messages and menus are displayed.

20–21

De (German) (Japanese)  
En (English) (Spanish)  
Fr (French)



### USB

Choose a transfer protocol for use when your camera is connected to a computer.

74

PTP  
Mass Storage

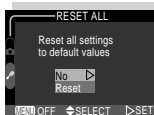

### Reset All ( mode only)

Reset camera settings to their default values.

76

No  
Reset





**The Playback Menu**

Pressing the MENU button when the mode selector is set to displays the PLAY BACK menu, which contains options for managing the pictures on the memory card.

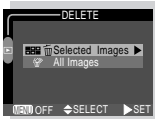

**Delete**  
Delete all or selected pictures. 86–87

- Selected Images
- All Images

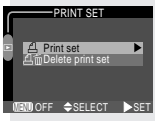

**Print Set**  
Select pictures for printing on a DPOF-compatible device. 88–89

- Print set
- Delete print set

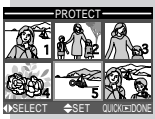

**Protect**  
Protect selected pictures from accidental deletion. 90

Select pictures for protection. Protected pictures are marked by a icon.



**Auto Transfer**  
Mark all pictures for transfer to a computer, or remove transfer marking from all pictures. 91

- All ON
- All OFF



**CF Card Format**  
This option is used to format memory cards for use in your camera. 72

- No Format





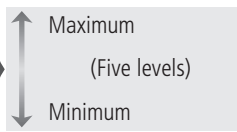









**Brightness**  
Adjust monitor brightness. 72



## The Scene Menu (A and M Modes)

Your Nikon digital camera offers a choice of twelve “scene” modes for common compositions. When a scene is selected from the SCENE menu, camera settings are automatically adjusted to produce optimal results for the selected scene, sparing you the necessity of adjusting camera settings one-by-one.

Mode	Description	
 <b>Portrait</b>	Use for portraits.	37
 <b>Party/Indoor</b>	Use to capture background details or the effects of candlelight and other indoor lighting.	37
 <b>Night Portrait</b>	Use when shooting portraits against a backdrop of night scenery.	38
 <b>Beach/Snow</b>	Use for bright subjects such as snowfields, beaches, and sunlight expanses of water.	38
 <b>Landscape</b>	Use to enhance outlines, colors, and contrast in skylines, forests, and other landscape shots.	38
 <b>Sunset</b>	Use to preserve the deep hues seen in sunsets and sunrises.	39
 <b>Night Landscape</b>	Use when taking landscape shots at night.	39
 <b>Museum</b>	Use where a flash is prohibited.	39
 <b>Fireworks Show</b>	Use to capture the expanding burst of light from a firework.	39
 <b>Close Up</b>	Use to capture vivid colors in close-up shots of flowers, insects, and other small objects.	40
 <b>Copy</b>	Use to copy text and line drawings from a white board or from a book or other printed matter.	40
 <b>Back Light</b>	Use when light is coming from behind your subject, throwing their features into shadow.	40

# Tutorial

## Getting Started

This chapter is divided into the following four sections:

### *First Steps*

This section details the steps you will take before using your camera for the first time.

### *Taking Pictures*

Read this section for a step-by-step guide to the basics of taking pictures with the COOLPIX 2500.

### *Review and Deletion*

Learn how to review and delete pictures while setting up your next shot.

### *Getting Creative*

Explore the creative possibilities of scene mode.

#### First Steps



16–23



#### Taking Pictures



24–30



#### Review and Deletion



31–35







#### Getting Creative



36–40



Before using your camera for the first time, you will need to complete the steps shown below.

<b>STEP 1</b>	Attach the Camera Strap		16
<b>STEP 2</b>	Insert the Battery and Memory Card		16–17
<b>STEP 3</b>	Check the Battery Level		18–19
<b>STEP 4</b>	Choose a Language		20–21
<b>STEP 5</b>	Set the Time and Date		22–23

### Step 1—Attach the Camera Strap

To ensure that the camera is not dropped and damaged, attach the strap as shown and wear it around your neck while using or carrying the camera.

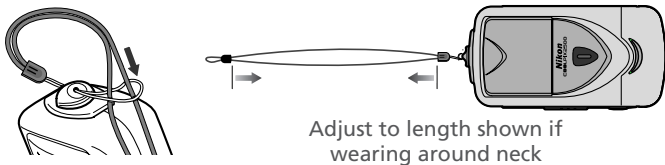

### Step 2—Insert the Battery and Memory Card

Your camera is powered by a rechargeable Nikon EN-EL2 lithium-ion battery, which can be charged using the MH-60 battery charger provided with the camera. To store pictures, your camera uses CompactFlash™ memory cards.

#### 2.1 Charge the battery

The EN-EL2 lithium-ion battery supplied with your camera is not fully charged at shipment. We recommend that you charge the battery before use. Instructions for charging the battery may be found in the instruction manual included with the battery charger.

#### 2.2 Turn the camera off

Before inserting or removing the battery or memory card, be sure the mode selector is in the “OFF” position.

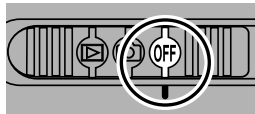

- 2.3 Open the battery-chamber/memory card slot cover**  
Slide the cover latch in the direction of the ☞ icon (A1) until the red dot is visible (A2), indicating that the cover is unlatched. Slide the cover out (B) and flip it open (C).

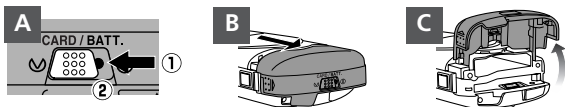

- 2.4 Insert the battery and memory card**  
Insert a fully-charged EN-EL2 battery with the “+” and “-” contacts oriented as shown in the label on the underside of the battery-chamber/memory card slot cover (A). Insert the memory card as shown in the label at the entrance to the memory card slot (B), sliding it in until it is firmly in place and the eject button pops up (the card is fully inserted when the top of the card is level with the top of the eject button).

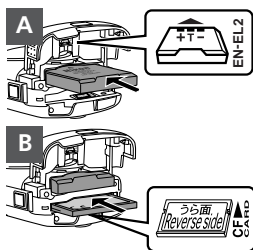

- 2.5 Close the battery-chamber/memory card slot cover**  
Close the battery chamber/memory card slot cover (A, B) and slide the latch in the direction of the ☜ icon until the red dot is hidden, indicating that the cover is latched (C). To prevent the battery or memory card being dislodged during operation, be sure that the cover is securely latched.

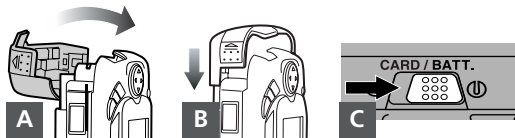

## Formatting Memory Cards

The memory card supplied with your camera is formatted at shipment. Other memory cards, however, must be formatted before first use. For information on formatting memory cards, see “Camera Setup: CF Card Format” (📖 72).

## Step 3—Check the Battery Level

Before using the camera, check the battery level in the monitor to make sure that the battery is charged.

### 3.1 Turn the lens section to shooting position

Before taking pictures, rotate the lens section to bring the lens into shooting position, as shown at right. If you omit this step before sliding the mode selector to , a message will be displayed in the monitor. To clear the message from the screen, rotate the lens section to shooting position.

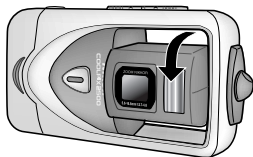

### 3.2 Turn the camera on

Slide the mode selector to .

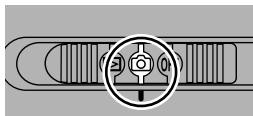

## ✓ Read Battery Warnings

*Read and follow all warnings and instructions supplied by the battery manufacturer.*

## ✓ The Lens Section

When adjusting the angle of the lens, rotate the lens section slowly; do not use excessive force. Care should be taken to avoid catching fingers, hair, or clothing between the lens section and the camera body.



## 💡 Removing the Memory Card

Memory cards can be removed without loss of data when the camera is off. When removing memory cards, turn the camera off and open the battery chamber/memory card slot cover (1). Press the eject button to partially eject the card (2), and then remove the card by hand.

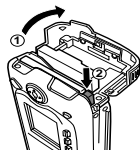

### 3.3 Check the battery level in the monitor

Display	Meaning	Camera status
NO ICON	Battery fully charged	Camera functions normally.
	Low battery	Recharge or replace battery without delay.
WARNING !! BATTERY EXHAUSTED	Battery exhausted	No pictures can be taken until battery has been recharged or replaced.

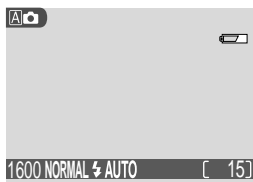

#### The Clock Battery

The camera's internal clock-calendar is powered by a separate, rechargeable power source, which is charged as necessary when the main battery is installed. If the camera has been stored for an extended period with the main battery removed, the clock may need to be reset. The clock power source can provide several days of back-up power after charging for about ten hours.

#### Removing the Battery

The battery can be removed without affecting pictures on the memory card. Before removing the battery, turn the camera off. Remove the battery by hand, holding it between your finger and thumb as shown at right. Do not use your fingernails.

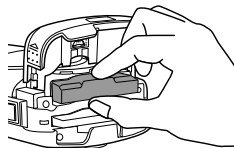

#### Alternative Power Sources

To power your camera continuously for extended playback or while the camera is connected to a computer, we recommend the EH-60 AC adapter kit (available separately;  95).

## Step 4—Choose a Language

Camera menus and messages can be displayed in your choice of German, English, French, Japanese, and Spanish.

4.1

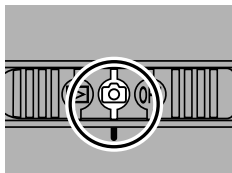

Slide mode selector to 

4.2

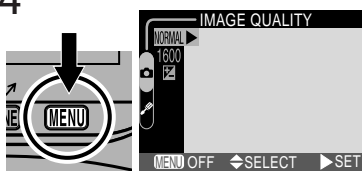

Press MENU button to display menu for current shooting mode

4.3

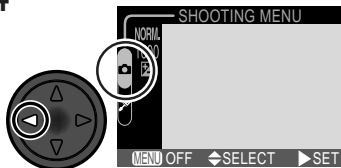

Highlight page tab

4.4

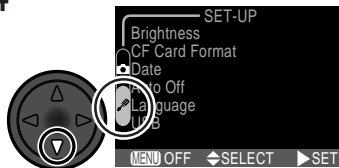

Highlight SET-UP menu page tab 

4.5

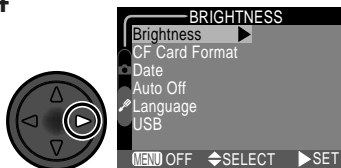

Position cursor in SET-UP menu

4.6



Highlight Language





4.7



Display options

4.8

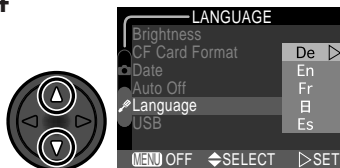

Choose a language from:

- De** Deutsch (German)
- En** English
- Fr** Français (French)
- 日** Japanese
- Es** Español (Spanish)

4.9

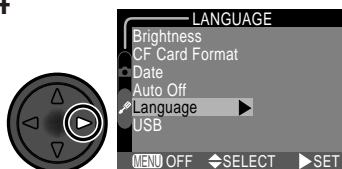



Return to SET-UP menu. If you have yet to set the time and date, proceed to Step 5.6 on the following page to set the time and date.

## Step 5—Set the Time and Date

Information on the time and date of recording is included with all pictures taken with your Nikon digital camera. To set the camera's internal clock to the correct time and date:

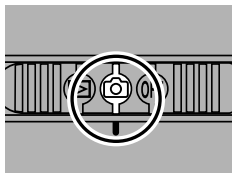
5.1



Slide mode selector to 

5.2

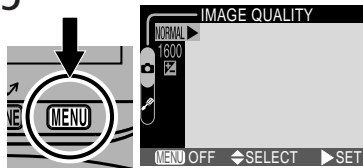

Press MENU to display menu for current shooting mode

5.3

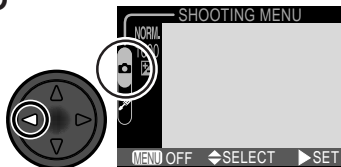

Highlight page tab

5.4

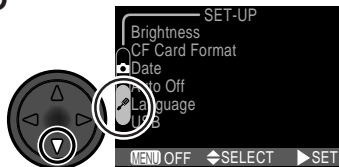

Highlight SET-UP menu page tab 

5.5

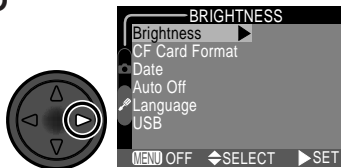

Position cursor in SET-UP menu

5.6

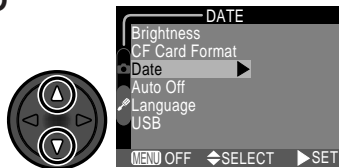

Highlight Date

5.7

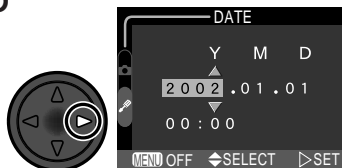

Display DATE menu

5.8

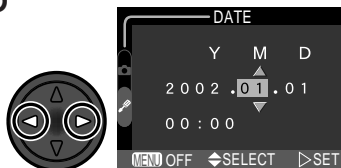

Highlight Year, Month, Day, hour, or minute (selected item blinks on and off in green)

5.9

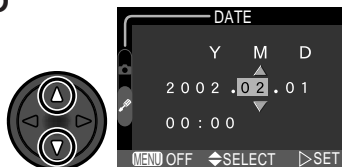

Edit selected item. Repeat steps 5.8–5.9 until all items have been set.

5.10

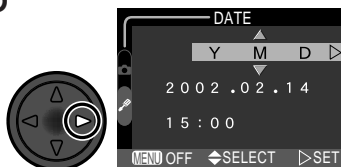

Highlight Y M D

5.11

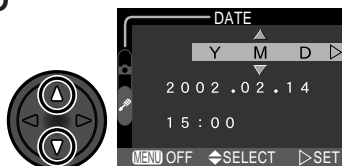



Choose order in which year, month, and day will be displayed

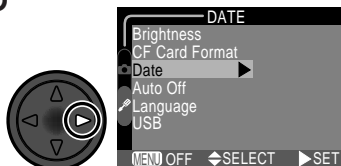





5.12



Save changes to settings and return SET-UP menu

Any pictures taken before the time and date have been set will have a time stamp of "0000.00.00 00:00." If the time and date have not been set, a flashing  ("Date not set") icon will be displayed in the top right corner of the monitor when the camera is in  mode.



This section details the basic steps involved in taking pictures in  mode. In this automatic, “point-and-shoot” mode, the majority of camera settings are controlled by the camera in response to shooting conditions, producing the best possible results in most situations.

<b>STEP 1</b>	Ready the Camera		24–25
<b>STEP 2</b>	Choose  Mode		25
<b>STEP 3</b>	Adjust Settings (Optional)		26
<b>STEP 4</b>	Frame the Picture		26–27
<b>STEP 5</b>	Focus and Shoot		28–29
<b>STEP 6</b>	Put the Camera Away		30

## Step 1—Ready the Camera

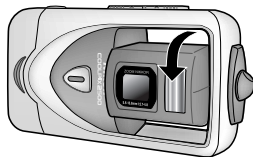

- 1.1 Turn the lens section to shooting position  
Rotate the lens as shown.



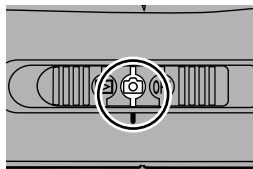

- 1.2 Slide the mode selector to   
When you slide the mode selector from OFF to , the flash-ready lamp under the monitor will light and the monitor will display a welcome message.



### 1.3 Check indicators in the monitor

If the low-battery icon (;  19) is displayed (A), recharge the battery or use an AC adapter (available separately).

The monitor also shows the number of pictures that can be taken at current settings (B). If the message "OUT OF MEMORY" appears in monitor, the memory card is full. Delete pictures ( 33–34), use a new memory card, or choose a lower quality or image size ( 60).



## Step 2—Choose Mode

2.1

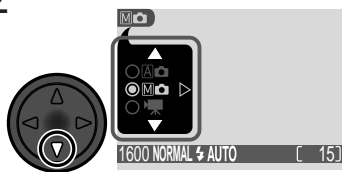

Press multi selector down to display shooting-mode menu\*

2.2

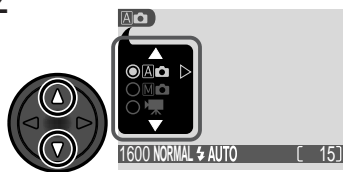

Select  (selected option is highlighted in green)

2.3

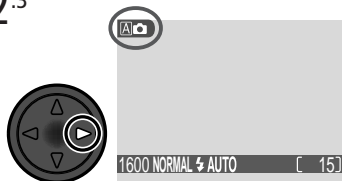

Press multi selector to right to exit menu (shooting-mode menu will also close if no operation is performed for about two seconds). Current shooting mode is shown by icon at top left corner of monitor.

\*When you press the multi selector down to display the shooting-mode menu, the current shooting mode will be highlighted. If  mode is already selected, press the multi selector to the right to exit the menu.

## Step 3—Adjust Camera Settings (Optional)

The following table shows the default settings for  mode. For more information, refer to the page numbers in the rightmost column.

Setting	Default	Description	
Flash mode	Auto	Flash fires automatically when lighting is poor.	53
Self timer	Off	Self-timer off.	55–56
Image quality	NORMAL	Pictures compressed for balance between quality and file size that is ideal for snapshots.	61
Image size	1600	Pictures are 1,600 × 1,200 pixels in size.	62
Exp. +/-	±0	No exposure compensation performed.	63

## Step 4—Frame the Picture

### 4.1 Adjust the lens angle

The lens section can be rotated 130° forward from its housing in the camera body, and 90° back toward the monitor. To frame a quick arms-length self-portrait, rotate the lens to point in the same direction as the monitor (in this position, the monitor will show a mirror image of what will appear in the final photograph).

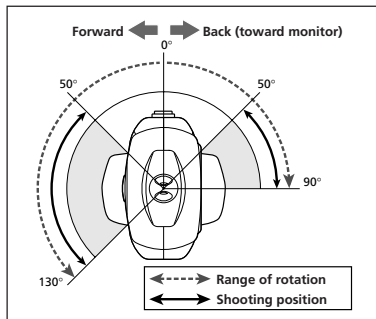

When the lens is obscured by the camera body, a warning will be displayed in the monitor and pictures can not be taken. To clear the message from the monitor, rotate the lens section to shooting position.

- 4.2 Ready the camera**  
Hold the camera steadily in both hands.

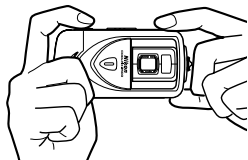

- 4.3 Frame your subject**  
Use the zoom buttons to frame your subject against the background.

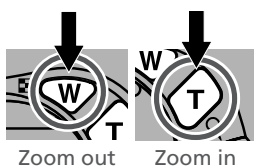

Indicator in monitor shows amount of zoom while either button is pressed

When the camera is zoomed all the way in, holding the  $\nabla$  button down for about two seconds extends the zoom range digitally (digital zoom;  $\text{Ⓜ}$  57). The zoom indicator turns yellow when digital zoom is in effect.

### Don't Block the Shot

To avoid dark or partially obscured pictures, keep your fingers and other objects away from the lens and flash window.

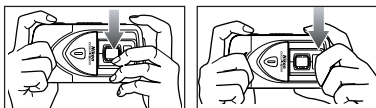

## Step 5—Focus and Shoot

### 5.1 Focus

Press the shutter-release button *halfway* to set focus and exposure. The camera will focus on the subject closest to the camera, and lock focus at this distance while the shutter-release button is pressed halfway.

With the shutter-release button pressed halfway, check the focus indicator and flash-ready lamp.

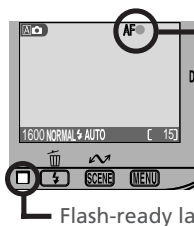
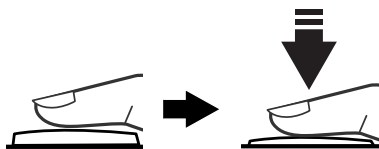

Focus indicator lights when shutter-release button is pressed halfway

Flash-ready lamp

Focus indicator	Green	Subject in focus.
	Flashes red	Camera unable to focus. Change your composition and try again.
Flash-ready lamp	On	Flash will fire when picture is taken.
	Flickers	Flash charging. Remove finger briefly from shutter-release button, then try again.
	Off	Flash off or not required.



### When Lighting Is Poor

If lighting is poor, the view through the camera lens may appear slightly “grainy” when viewed in the monitor.



- 5.2 Take the picture**  
*Smoothly press the shutter-release button the rest of the way down to take a picture.*



After each shot, the picture you have just taken will be displayed briefly in the monitor before being recorded to the memory card. If you are not satisfied with the results, you can delete the picture instantly by pressing the  button. If you need more time to study the picture, you can pause the display for up to ten seconds by pressing the **SCENE**  button. For more information, see “Keep or Delete” ( 58).

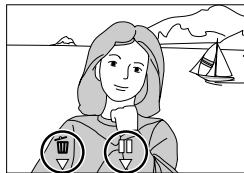



## Getting Good Results with Autofocus

Autofocus performs best when there is contrast between the subject and background and the subject is evenly lit. It does not perform well if the subject is very dark or moving rapidly, if there are objects of sharply differing brightness in the scene (e.g., the sun is behind your subjects and their features are in deep shadow), or if the subject contains objects at different distances from the camera (e.g., the subject is inside a cage).

## During Recording

While pictures are being recorded to the memory card, a  icon will be displayed in the monitor.

Pictures taken while earlier images are being recorded are stored in a temporary memory buffer. When the buffer is full, an hourglass  icon will be displayed and the shutter release will be disabled.

*Do not turn the camera off, remove the memory card, or remove or disconnect the power source while  or  is displayed.*

## Step 6—Put the Camera Away

- 6.1** Turn the camera off  
Turn the camera off to save battery power.

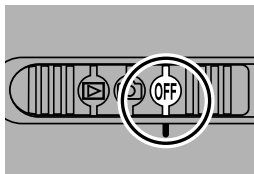

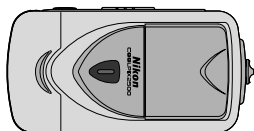

- 6.2** Return the lens section to the closed position  
To protect the lens, return the lens section to its housing in the camera body.



# Review and Deletion

Quick Review

Using the quick review function on your Nikon digital camera, you can view the results of earlier attempts while setting up the next shot, and use what you see to change camera settings or to choose a better angle. Once you have the shot you want, you can delete your failures instantly to make room for more shots on the memory card.

To use quick review, the camera must be in  mode. Press the **QUICK**  button once to display the most recent picture at the top left corner of the monitor, twice to display pictures full screen. Pressing the button a third time returns you to  mode.

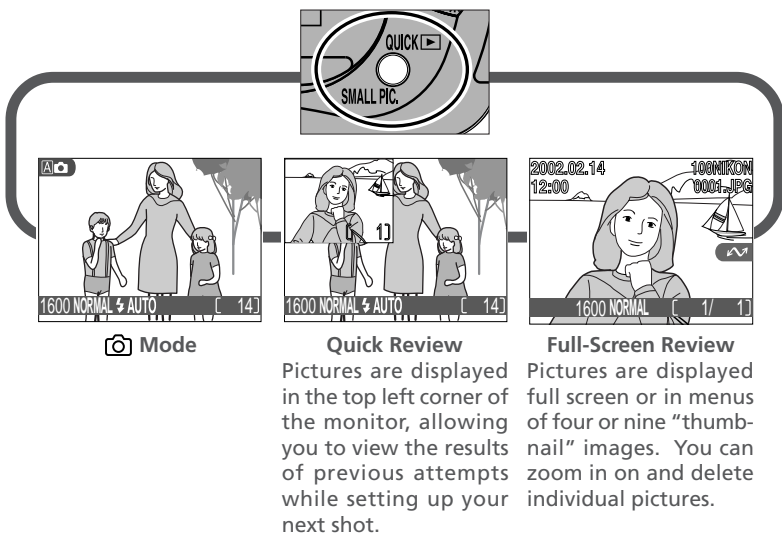

## Quick Review

The following operations can be performed in quick review:

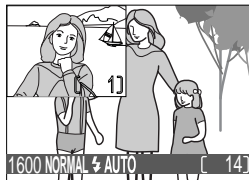

To	Press	Description
View other pictures		Press the multi selector up to view pictures recorded before the current photo, down to view pictures recorded after the current photo.
View current picture full screen	QUICK	Enter full-screen review (see opposite) with the current picture displayed full screen.
Return to shooting mode	Shutter release	To return to shooting mode, press the shutter-release button halfway.







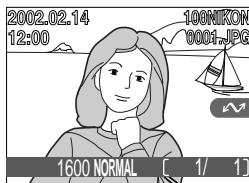







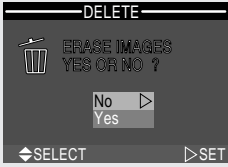



All other camera controls function as they do in shooting mode.

## Full-Screen Review



The following operations can be performed in full-screen review:























To	Press	Description
View other pictures		Press the multi selector up to view pictures recorded before the current photo, down to view pictures recorded after the current photo. Keep multi selector pressed to scroll rapidly to the desired frame number.

To	Press	Description
View multiple pictures		Press the  (  ) button to display up to nine pictures at a time as small thumbnail previews (see following page).
Delete current picture		<p>A confirmation dialog will be displayed. Press multi selector up or down to highlight option, press right to select.</p>  <ul style="list-style-type: none"> <li>• Select <b>No</b> to exit without deleting picture</li> <li>• Select <b>Yes</b> to delete picture</li> </ul>
Zoom photo in		Press the  (  ) button for an enlarged view of the current photo (  81). While the photo is zoomed in, use the multi selector to view areas not visible in the monitor. To cancel zoom, press  .
Select current picture for transfer to a computer		Pictures selected for transfer are marked with a  icon. Turn this marking on or off to select the pictures that will be transferred to a computer at a later date (  44).
Hide or display photo info		Press multi selector to left to hide or display photo info superimposed on picture in monitor (  7).
Return to  mode	Shutter release/ 	To end review and return to shooting mode, press the <b>QUICK</b>  button or press the shutter-release button halfway.

## Thumbnail Review

Pressing the  () button in full-screen review displays a menu of four thumbnail images. The following operations can be performed while thumbnails are displayed:





To	Press	Description
Highlight pictures		Press the multi selector up, down, left, or right to highlight thumbnails.
Change number of pictures displayed	  / 	With four thumbnails displayed, press the  button once to view nine thumbnail images. Press  (  ) to “zoom in” from nine thumbnails to a four-thumbnail view or, when four thumbnails are displayed, to view highlighted picture full size.
Delete highlighted picture	 (  )	A confirmation dialog will be displayed. Press multi selector up or down to highlight option, press to right to select. <div data-bbox="440 847 699 1029" style="border: 1px solid black; padding: 5px; margin: 10px 0;"> <p style="text-align: center;">DELETE</p> <p style="text-align: center;"> ERASE IMAGES YES OR NO ?</p> <p style="text-align: center;">No </p> <p style="text-align: center;">Yes </p> <p style="text-align: center;"> SELECT <span style="float: right;"> SET</span></p> </div> <ul style="list-style-type: none"> <li>• Select <b>No</b> to exit without deleting picture</li> <li>• Select <b>Yes</b> to delete picture</li> </ul>
Select highlighted picture for transfer to a computer	 (  )	Pictures selected for transfer are marked with a  icon. Turn this marking on or off to select the pictures that will be transferred to a computer at a later date (  44).
Return to  mode	Shutter release/ QUICK 	To end review and return to shooting mode, press the QUICK  button or press the shutter-release button halfway.

---

## Playback Mode ( 77)

---

This section describes quick review, which allows you to view pictures without leaving  mode. To learn about additional playback options available in  (playback) mode, see “Playing Pictures Back” ( 77).

# Getting Creative

## Scene Selection

SCENE

Tutorial—Getting Creative

Your Nikon digital camera offers a choice of “scene” modes for common compositions, such as portraits, landscapes, and close-ups, which require special combinations of settings that apply to any scene of the same type. When a scene is selected from the SCENE menu, camera settings are automatically adjusted to produce optimal results for the selected composition, sparing you the necessity of adjusting camera settings one-by-one.

Scene selection is only available in **A** and **M** modes (for information on choosing a shooting mode, see “Tutorial: Taking Pictures”;  25). To choose a scene:

1



Press SCENE button to display menu of scene choices

2

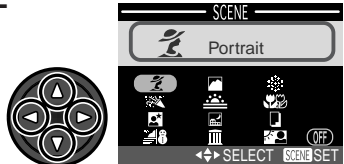

Make selection (chosen scene takes effect when option is highlighted; highlighted scene shown by icon and caption in monitor)

3

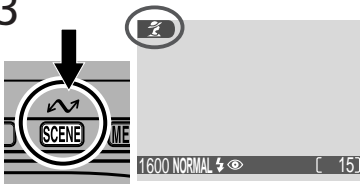

Press SCENE button to return to shooting mode (selected scene shown by icon in monitor)



In scene mode, you can adjust flash (👁️ 53) and self-timer (👁️ 55) settings (restrictions may apply depending on the scene selected). Pressing the **MENU** button will display the SHOOTING menu (👁️ 59). To return to **A**📷 or **M**📷 mode, select **OFF** in the SCENE menu.

The following pages describe when to use each scene mode.

### Portrait



Use for portraits. Main subject stands out clearly while background details are softened, lending the composition a sense of depth.

- Degree to which background details are softened depends on the amount of light available

### Party/Indoor



Use for shots that include details of the background behind the main subject, or to capture the effects of candlelight and other indoor background lighting.

**Camera Shake:** ☆

## Camera Shake



At slow shutter speeds, a 📷 icon appears in the monitor. Pictures taken at these speeds may be blurred by inadvertent camera movement (“camera shake”). While use of a tripod is recommended when this icon is displayed, other methods that may be successful in preventing blurring at a given setting are indicated by the number of stars in the “Camera Shake” rating:

- ☆ Support the camera steadily in both hands with your elbows against your torso.
- ☆☆ Place the camera on a flat, level surface such as a wall or table.

## Night Portrait



Use for shots that provide a natural balance between the main subject and the background when shooting portraits against a backdrop of night scenery.

- Flash mode is set to   (auto with red-eye reduction;  53).

**Camera Shake:** ☆

## Beach/Snow



Vividly captures the brightness of such subjects as snowfields, beaches, or sunlight expanses of water.

## Landscape



Use for vivid landscape shots that enhance outlines, colors, and contrast in such subjects as skylscapes and forests.

- Focus is fixed at infinity, allowing the camera to focus on distant scenes through foreground objects such as a window or a screen of branches. The focus indicator (**AF●**) is not displayed.
- Flash turns off () automatically.

## Noise Reduction

“Noise” in the form of randomly-spaced, brightly-colored pixels tends to appear in pictures taken at slow shutter speeds. This effect is particularly noticeable in dark areas of the picture. At settings of **Night Portrait** and **Night Landscape**, pictures taken at slow shutter speeds are processed to reduce noise before being saved to the memory card. As result, more time is required to save pictures to the memory card.

### Sunset



Preserves the deep hues seen in sunsets and sunrises. Flash turns off (⚡) automatically.

**Camera Shake:** ★

### Night Landscape



A slow shutter speed is used to produce stunning night landscapes.

- Focus is fixed at infinity; the focus indicator (AF●) is not displayed.
- Flash turns off (⚡) automatically.

**Camera Shake:** ★★

### Museum



Flash turns off (⚡) automatically. Use indoors where flash photography is prohibited (for example in museums and art galleries) or in other settings in which you do not want to use the flash.

- The Best Shot Selector (BSS;  67) turns on automatically, reducing the effects of inadvertent camera movement.
- Photography may be prohibited altogether in some settings. Be sure to obtain permission first.

**Camera Shake:** ★

### Fireworks Show



Slow shutter speeds are used to capture the expanding burst of light from a firework. The camera responds more rapidly to the shutter-release button, ensuring that you can capture the start of the burst.

- Focus is fixed at infinity; the focus indicator (AF●) is not displayed.
- Flash turns off (⚡) automatically.
- Follow the firework as it ascends and press the shutter-release button all the way down at the start of the burst.
- Self-timer can not be used ( 56).

**Camera Shake:** ★★



## Close Up



Camera is set to focus on objects as close as 4 cm (1.6") from the lens, making it possible to capture vivid colors in close-up shots of flowers, insects, and other small objects, with the background artistically blurred.

- Camera automatically selects middle zoom position for a minimum focus distance of 4 cm/1.6" (measured from lens). Minimum focus distance will increase if camera is zoomed in or out.
- Camera focuses on subject at center of frame.

**Camera Shake:** ☆

## Copy



Provides clear pictures of text or drawings on a white board, business card, or in other printed matter.

- Colored text and drawings may not show up well in the final picture.



## Back Light





Use when light is coming from behind your subject, throwing their features into shadow, or when your subject is in the shade but the background is brightly lit. The flash will fire automatically to "fill in" (illuminate) shadows.

- Flash is set to ⚡ (fill flash;  53).

## OFF



Select this item to return to the shooting mode ( or ) in effect when scene mode was selected. The mode last in effect will be displayed in the monitor when this option is highlighted.



# **Connections**

*Your Camera and Your Computer*

---

Your Nikon digital camera stores pictures as digital data. Instead of making the trip to a developer and getting negatives, you can simply copy your pictures to a computer for long-term storage using the Nikon View 5 software provided with your camera. Once transferred to your computer, your pictures can be viewed, printed, sent to your acquaintances via e-mail, or saved to a Zip disk or other removable media for delivery to a photofinisher. Any copies stored on the memory card after transfer can be deleted to make way for new pictures, which you can then add to the growing digital photo album on your computer.

## Before You Begin: Installing Nikon View 5

Before copying pictures to your computer, you will need to install Nikon View 5, an application that allows you to transfer pictures from the camera memory card to a computer hard disk and view them on the computer monitor. To install Nikon View 5, you must have a computer running one of the following operating systems:

<b>Windows</b>	Pre-installed versions of Windows XP Home Edition, Windows XP Professional, Windows 2000 Professional, Windows Millennium Edition (Me), or Windows 98 Second Edition (SE).
<b>Macintosh</b>	Mac OS 9.0, 9.1, 9.2, Mac OS X (10.1.2 or later). Only models with built-in USB ports supported.

The first step to installing Nikon View 5 is to read the installation instructions. These are included on the reference CD provided with your camera.



### 1 Insert the reference CD

After turning on your computer and waiting for the operating system to start up, place the reference CD in a CD-ROM drive.



If you are using a Macintosh computer, the reference CD window will open automatically on the desktop. Windows users will need first to double-click the **My Computer** icon and then the **Nikon** icon to open the reference CD window.

## Already Have Nikon View?

In order to transfer pictures to your computer using the UC-E3 USB cable, the COOLPIX 2500 requires the version of Nikon View 5 provided with the camera. If you have a version of Nikon View that was included with another Nikon digital camera, you will need to upgrade to the version provided with the COOLPIX 2500.

## 2 Install Adobe Acrobat Reader

The installation instructions are in Portable Document Format (PDF). To view the instructions, you will need Adobe Acrobat Reader 4.0 or later. If you have already installed this version of Acrobat, proceed to Step 3.

To install Adobe Acrobat Reader, open the folder for the language of your choice and double-click the installer icon. The installer start-up screen will be displayed; follow the on-screen instructions to complete installation.

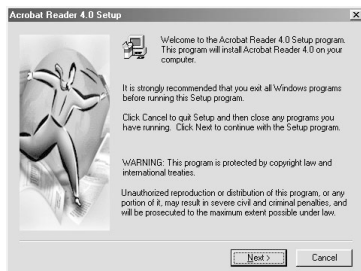

Start-up screen (Windows)



Start-up screen (Macintosh)

## 3 Read installation instructions for Nikon View 5

Once you have installed Adobe Acrobat Reader, double-click the **INDEX.pdf** icon in the root directory of the reference CD to view a clickable index of the documentation available for Nikon View 5. Follow the links to view the installation instructions for your computer system. If desired, you can print the installation instructions using the **Print...** command in the Acrobat **File** menu, and follow along during installation of Nikon View 5.

### Before Installing Nikon View 5

Before installing Nikon View 5, be sure to exit all other programs, including Adobe Acrobat Reader and any virus-checking software.

## Making the Connection: Connecting to Your Computer

Once you have installed Nikon View 5, you are ready to transfer photographs and movies to your computer. Pictures can be transferred via a direct USB connection between the camera and computer, or by removing the memory card from the camera and inserting it in a card reader or PC card slot.

### Direct Connection: Connecting Your Camera by Cable







If your computer has a built-in USB interface, you can connect it to your camera using the UC-E3 cable provided.

#### 1 Slide the mode selector to

The camera will enter playback mode ( 78) with your most recent picture displayed full frame in the monitor.



#### 2 Select the pictures to be transferred

Press the  () button to display the pictures on the memory card in “contact sheets” of four or nine thumbnails ( 80). Confirm that only the pictures you want to copy to the computer are marked with a  icon. To remove the  icon from a picture, or to select an unmarked picture for transfer, highlight the image with the multi selector and press the  ( **SCENE**) button.





#### 3 Turn the camera off

Turn the camera off before connecting it to a computer.



### Transferring More than 999 Pictures

No more than 999 pictures can be transferred at one time using the  ( **SCENE**) button. To copy more pictures, use Nikon View 5. See the *Nikon View 5 Reference Manual* (on CD) for details.



## 5 Connect the camera and computer

Connect the UC-E3 USB cable as shown below. Use the flat connector for connection to the computer, and connect the other end of the cable to the camera's USB connector. Do not connect the camera via a USB hub or keyboard.

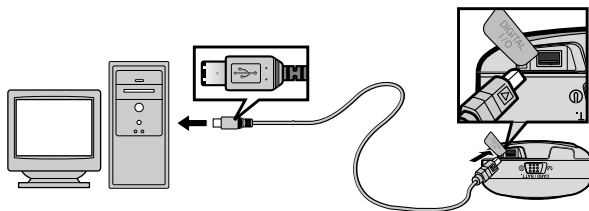

## 6 Turn the camera on

Slide the mode selector to or . If the UC-E3 is connected, the monitor will remain off, and all controls except the (SCENE) button and power switch will be inactive.



### Choosing a USB Protocol

The COOLPIX 2500 supports two USB protocols: Mass Storage (the default option) and Picture Transfer Protocol (PTP). Before connecting the camera to a computer running Windows XP Home Edition, Windows XP Professional, or Mac OS X, set the **USB** option in the camera setup menu to **PTP** ( 000). If you are connecting the camera to a computer running Windows 2000 Professional, Windows Millennium Edition (Me), Windows 98 Second Edition (SE), Mac OS 9.0, 9.1, 9.2 and have changed the USB setting to **PTP**, return to the **USB** menu and select **Mass Storage**.

### Before Connecting the Camera

Before connecting your camera to a computer, make sure that Nikon View 5 is installed.

## 7 Press the (SCENE) button

When the camera is connected and turned on, Nikon View 5 will start automatically (see the reference CD for details). Once Nikon View 5 has started, press the  (SCENE) button to begin copying the pictures selected in Step 2 to the computer. The message “PREPARING TO TRANSFER” will appear in the camera monitor.

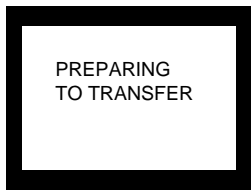

## 8 Wait for the pictures to be transferred to the computer

While pictures being copied to the computer, the camera monitor will show “TRANSFERRING IMAGE TO COMPUTER.” Do not turn the camera off, remove the memory card, or disconnect the cable while transfer is in progress.



## 9 Remove the camera from the system

When all marked pictures have been transferred, the message “TRANSFER COMPLETED” will be displayed in the camera monitor. Before disconnecting the cable or turning the camera off, you must remove the camera from the system as follows:

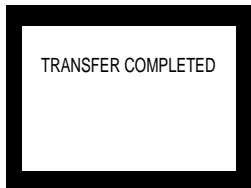



### *Windows XP Home Edition/Windows XP Professional*

Click the “Safely Remove Hardware” icon  in the taskbar and select **Safely remove USB Mass Storage Device** from the menu that appears.



## Mac OS X

Pictures can not be transferred using the camera  (SCENE) button in Mac OS X 10.1.2. Use the  button in Nikon View 5 to transfer pictures. See the *Nikon View 5 Reference Manual* (on CD) for details. The camera  (SCENE) button can be used to transfer images in Mac OS X 10.1.3 or later.

### Windows 2000 Professional

Click the “Unplug or Eject Hardware” icon  in the taskbar and select **Stop USB Mass Storage Device** from the menu that appears.



### Windows Millennium Edition (Me)

Click the “Unplug or Eject Hardware” icon  in the taskbar and select **Stop USB Disk** from the menu that appears.



### Windows 98 Second Edition (SE)

In My Computer, click with the right mouse button on the removable disk corresponding to the camera and select **Eject** from the menu that appears.



### Mac OS X

Drag the “NO\_NAME” camera volume into the Trash.



Mac OS X

### Mac OS 9

Drag the “untitled” camera volume into the Trash.



Mac OS 9

Once you have removed the camera from the system, you can disconnect the interface cable or turn the camera off.

## Disconnecting the Camera

Before turning the camera off or disconnecting the interface cable, be sure that transfer is complete and that the camera displays the message “TRANSFER COMPLETED.” While transfer is in progress, do not disconnect the USB cable, turn the camera off, or remove the memory card from the camera.

## Use a Reliable Power Source

When transferring data between the camera and the computer, be sure that the battery is fully charged. If in doubt, recharge the battery before beginning transfer or use the optional EH-60 AC adapter kit.

## Reading Pictures from Memory Cards

If you have a CompactFlash™ card reader or your computer is equipped with a PC card slot, you can transfer pictures directly from the memory card. Before inserting the memory card in a card reader or card slot, turn the camera off and remove the card from the camera.

### 1 Turn the computer on

Turn the computer on and wait for the operating system to start up.

### 2 Insert the memory card

If you are using a PC card slot, insert the memory card into a PC card adapter (see note below), and then insert the adapter into the PC card slot. If you are using a card reader, insert the memory card directly into the card reader. If installed, Nikon View 5 will detect cards from Nikon digital cameras and start automatically. See the *Nikon View 5 Reference Manual* (on CD) for information on transferring pictures to your computer.

---

### CompactFlash™ Card Readers

---

Before using a card reader, be sure to read all documentation provided by the manufacturer.

---

### PC Card Adapter

---

To read CompactFlash™ memory cards using a PC card slot, you will require an EC-AD1 PC-card adapter (shown at right), available separately from Nikon.

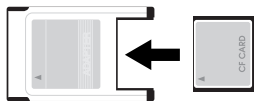

---

## Removing the Memory Card

---

Be sure that transfer is complete before removing memory cards from the card reader or PC card slot.

Before removing the memory card from a PC card slot or card reader, you will need to remove the card from the system:

*Windows XP Home Edition/Windows XP Professional*

Click the "Safely Remove Hardware" icon () in the taskbar and remove the memory card from the system.

*Windows 2000 Professional/Windows Millennium Edition (Me)*

Click the "Unplug or Eject Hardware" icon () in the taskbar and remove the memory card from the system.

*Windows 98 Second Edition (SE)*

In My Computer, right click on the removable disk corresponding to the memory card and select **Eject** from the menu that appears.

*Mac OS X*

Drag the "NO\_NAME" volume that represents the memory card into the Trash.



*Mac OS 9*

Drag the "untitled" volume that represents the memory card into the Trash.

---

## File and Folder Names

---

Pictures taken with the COOLPIX 2500 are identified by file names that begin with "DSCN" or, in the case of images created with the small picture function ( 82), "SSCN," followed by a four-digit file number assigned automatically by the camera (e.g., "DSCN0001"). Each file name ends in a three-letter "extension" that identifies the type of picture: ".JPG" for photographs and ".MOV" for movies. Picture files are stored in folders created automatically by the camera and named with a three-digit folder number followed by "NIKON" (e.g., "100NIKON"). The folder name and file number can be viewed in full-screen review and full-frame playback, when they are displayed in the top right corner of the monitor ( 7).



# Taking Pictures

*The Details*

Beyond Point-and-Shoot



52–58



Fine-Tuning Camera Settings



59–68



---

In “Tutorial: Taking Pictures,” you learned the basic order of operations for taking pictures in  mode. This chapter details the options available for taking pictures in all shooting modes. It is divided into the following sections:

## ***Beyond Point-and-Shoot***



Read this section for advice on the most frequently-used camera controls, including shooting-mode and scene selection, flash mode, the self-timer, and zoom, as well as for information on the operations that can be performed while pictures are displayed in the monitor after shooting.

## ***Fine-Tuning Camera Settings***



This section details the options available in the SHOOTING menu.

## or **Movie**: Choosing a Shooting Mode







In  mode, you have a choice of four basic shooting modes (for information on choosing a shooting mode, see “Tutorial: Taking Pictures”;  24):

### **Auto**

Auto produces good results in a wide range of situations. Use for snapshots or when you want control over image quality ( 61), image size ( 62), and exposure compensation ( 63) while leaving the camera in charge of other settings.



### **Manual**

Choose this mode for complete control over all camera settings, including white balance ( 64), sharpening ( 68), and BSS ( 67). You can also choose to take pictures in continuous sequence while the shutter-release button is held down ( 66).

This mode is used to record NORMAL-quality silent movies 320 × 240 pixels in size (QVGA) at a rate of about fifteen frames per second. Recording begins when the shutter-release button is pressed all the way down and ends when the shutter-release button is fully pressed a second time.

### **Movie**



- In place of the number of exposures remaining, the exposure-count display in monitor shows the length of the movie that can be recorded.
- Movie ends automatically after fifteen seconds or when no more space is available on the memory card.
- Movies are stored as QuickTime movie files ending in “.MOV”.
- The flash turns off () automatically.
- Menus and scene-selection are disabled in movie mode
- If the lens is rotated to point in the same direction as the monitor during recording, the display in the monitor will be inverted and the movie will be recorded upside down.





Pressing the **SCENE** button in  or  mode displays a menu of twelve “scenes,” where you can choose an option suited to your subject and composition and let the camera adjust settings for best results. For more information, see “Tutorial: Getting Creative” ( 36).





## Flash Photography: The ⚡ Button

In  mode, the ⚡ button controls the flash. Four flash modes are available (restrictions may apply in scene mode;  36):

Mode	How it works	When to use it
 <b>AUTO</b> Auto	Flash fires when lighting is poor.	Best choice in most circumstances.
 Auto with red-eye reduction	Pre-flash fires before main flash. This causes subjects' pupils to contract before photo is taken, minimizing "red-eye" effect caused by flash reflecting from retina.	Use for portraits (works best when subjects are well within range of flash and looking at pre-flash). Because a slight delay occurs after the shutter-release button is fully pressed to allow the pre-flash to take effect, this setting is not recommended with erratically-moving subjects or in other situations in which you want the camera to react quickly.
 Flash Cancel (off)	Flash will not fire even when lighting is poor.	Use when subject is outside range of flash, to capture natural lighting under dim light, or where use of a flash is prohibited. Use of a tripod is recommended to prevent blurring.
 Anytime Flash (fill flash)	Flash fires whenever picture is taken.	Use to "fill-in" (illuminate) shadows and back-lit subjects.

### The Flash-Ready Light

A short pause is required between exposures for the flash system to charge. If the shutter-release button is pressed halfway while the flash is charging, the flash-ready light under the monitor will flicker. Remove your finger briefly from the shutter-release button and try again.

The flash mode can be selected with the  button:

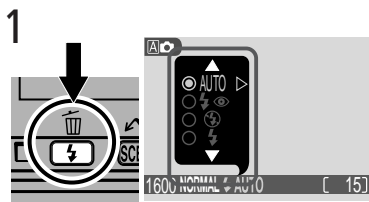

Press  button to display flash-mode menu

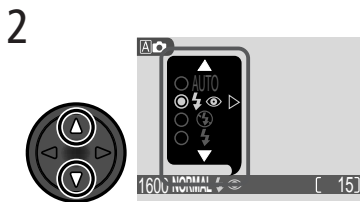

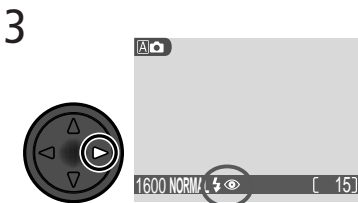

Press multi selector up or down until desired mode is highlighted



Press multi selector to right to exit menu (flash-mode menu will also close if no operation is performed for about two seconds). Current flash mode is shown by icon at bottom of monitor.

## The ISO (Sensitivity Gain) and (Camera Shake) Icons

When lighting is poor and the flash is off () , the camera will automatically raise its sensitivity to light for faster exposures, minimizing blur caused by camera shake. When sensitivity is raised above the default value, an **ISO** icon will appear in the monitor to warn that “noise” may appear in the final picture. If the shutter speed required for exposure is very slow, a  (camera shake) icon will appear in the monitor. Use of a tripod or support is recommended.



## Delaying Shutter Release: Choosing a Self-Timer Mode

When the self-timer is on, pictures will not be taken until ten seconds after the shutter-release button is pressed all the way down, giving you time to position yourself in front of the camera when taking pictures in which you want to appear yourself. When taking low-light or close-up shots with the flash off, the self-timer can be used to prevent pictures from being blurred by camera movement that occurs when the shutter-release button is pressed.

To use the self-timer:

### 1 Position the camera

Mount the camera on a tripod (recommended) or rest it on a flat, stable surface.

### 2 Turn the self-timer on

The self-timer setting is controlled with the multi selector.

2.1

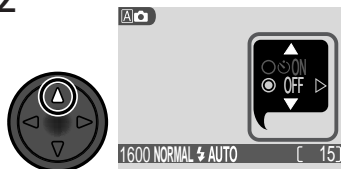

Press multi selector up to display self-timer menu

2.2

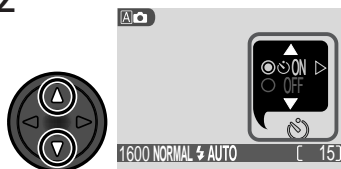

Press multi selector up or down to highlight ON

2.3



Press multi selector right to exit menu (self-timer menu will also close if no operation is performed for about two seconds). When timer is on, self-timer icon is displayed in monitor.

### 3 Compose the picture

Adjust camera settings and frame the picture. Remember that the camera will focus on the closest object; compose your picture with no other objects between your subject and the camera.

### 4 Start the timer

Press the shutter-release button all the way down to lock focus and activate the timer.



Full press



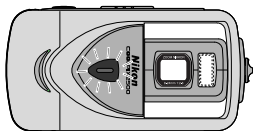

Count-down timer in monitor shows number of seconds remaining until picture is taken

The self-timer lamp on the front of the camera will start to blink when the shutter-release button is pressed, and continue to blink until one second before the photo is taken. The self-timer lamp will stay lit during the final second to warn that the shutter is about to be released. To stop the timer before a picture is taken, press the shutter-release button.



### Restrictions on the Self-Timer

The self-timer is not available in movie mode ( 52) or when **Fireworks Show** ( 39) is selected in scene mode.



## Framing Pictures: Optical and Digital Zoom

Your Nikon digital camera offers two kinds of zoom: optical zoom, in which the camera's telescoping lens can be used to magnify the subject up to 3 ×, and digital zoom, in which digital processing is used to further magnify the image up to 4 ×.

### Optical Zoom

Photos can be framed in the monitor using the zoom buttons.



Zoom out



Zoom in



Indicator in monitor displays amount of zoom while either button is pressed

Optical zoom is not available in movie mode, although digital zoom can be used to magnify the subject up to about 3 ×.

### Digital Zoom

At the maximum optical zoom position, holding the  button down for two seconds triggers digital zoom.

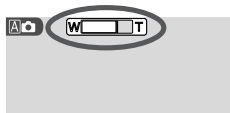



Maximum optical zoom position



Hold for 2 s



Zoom indicator turns yellow in digital zoom range









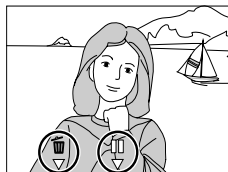

The camera can be zoomed in and out in the digital zoom range by pressing the  and  buttons. To restore ordinary optical zoom, press  until the zoom indicator turns white.

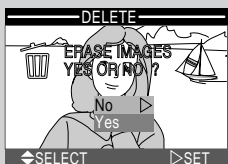
In digital zoom, data from the camera's image sensor are processed digitally, enlarging the center portion of the picture to fill the frame. Unlike optical zoom, digital zoom does not increase the amount of detail visible in the picture. Instead, details visible at maximum optical zoom are enlarged, producing a slightly "grainy" image. While digital zoom is in effect, the camera focuses on the subject in the center of the frame, even if objects in other areas of the frame are closer to the camera.

## Keep or Delete: Picture Review

After each shot, the picture you have just taken will be displayed briefly in the monitor until being recorded to the memory card. The following operations can be performed while the picture is displayed:

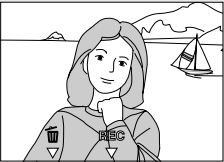

To	Press	Description
Delete picture	 	<p>A confirmation dialog will be displayed. Press multi-selector up or down to highlight option, press to right to select.</p>  <ul style="list-style-type: none"> <li>• Select <b>No</b> to save picture and return to shooting mode</li> <li>• Select <b>Yes</b> to delete picture</li> </ul>
Pause display	 	<p>Display will be paused for ten seconds and pause icon () will change to . During this time, you can press  (<b>SCENE</b>) to record picture and return to shooting mode, or press   to delete photo as described above. Picture will be recorded automatically if no operations are performed for ten seconds.</p> 

# Fine-Tuning Camera Settings

The -Mode Menu

In  mode, changes to some settings are made with the help of a SHOOTING menu that appears when the **MENU** button is pressed.

To make selections from the SHOOTING menu:

1

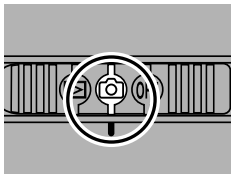

Slide mode selector to 

2

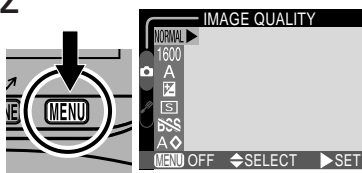

Press **MENU** button to display menu for current mode

3

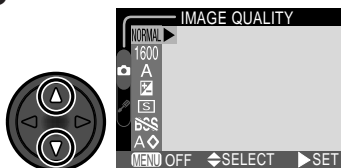

Highlight menu item

4

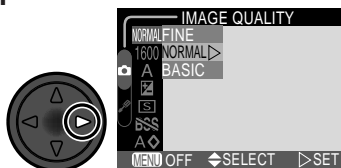

Display options

5

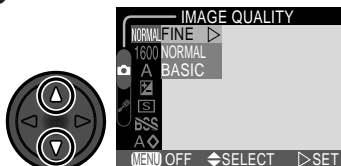

Highlight option  
(to return to previous menu, press multi selector to left)

6

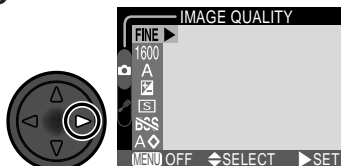

Make selection

To exit the menu and return to shooting mode, press the **MENU** button.

The options available in the SHOOTING menu depend on the shooting mode selected. No menu is available in movie mode.

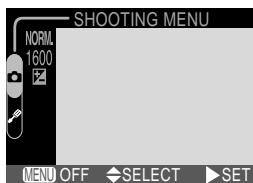

Shooting menu  
([A] camera, scene)

Option	Eye icon
IMAGE QUALITY	61
IMAGE SIZE	62
EXP. +/-	63



Shooting menu  
([M] mode)

Option	Eye icon
IMAGE QUALITY	61
IMAGE SIZE	62
WHITE BALANCE	64–65
EXP. +/-	63
CONTINUOUS	66
BEST SHOT SELECTOR	67
IMAGE SHARPENING	68

## Making Effective Use of Memory: Image Quality and Size

Together, image quality and size determine how much space each picture occupies on the memory card, which in turn determines the total number of pictures that can be stored. The current image size and quality are shown in the monitor.





To get an idea of how different settings for image quality and size affect the number of pictures that can be stored, view the table below, which shows the approximate number of pictures that can be stored on eight- and sixteen-megabyte memory cards at different combinations of image quality and size.

	8-MB memory card				16-MB memory card			
	1600	1280	1024	640	1600	1280	1024	640
FINE	8	12	18	43	16	24	37	86
NORMAL	15	23	34	71	31	47	69	144
BASIC	29	43	60	113	59	86	121	229

\* Figures are approximate. File size of JPEG images depends on scene recorded, producing wide variations in number of images that can be stored.

## Image Quality

To reduce the amount of memory that each shot occupies, pictures are compressed as they are saved to the memory card. Compression selectively reduces the quality of the image; the more the picture is compressed, the more noticeable this loss of quality is likely to be (the actual effect depends on the size of the picture when printed or displayed and on the type of subject). The image-quality menu allows you to choose the amount of compression performed.



Option	Compression ratio (approx.)	Description
FINE	1 : 4	Fine image quality, suitable for enlargements or high-quality prints.
NORMAL	1 : 8	Normal image quality, suited to most applications.
BASIC	1 : 16	Basic image quality, suitable for pictures that will be distributed by e-mail or used in web pages.

## Image Size

 *Image size* refers to the physical dimensions of the image, measured in pixels. Choose an image size according to the space available on the memory card and the task at hand.



Option	Size (pixels)	Description
<b>1600</b>	1,600 × 1,200	Suited to print sizes ranging from large photo album through to A5 (roughly 8" × 6").
<b>1280</b>	1,280 × 960	Suited to postcard-size prints.
<b>1024</b>	1,024 × 768	Suited to printing at smaller sizes (for example, as an illustration in a letter or report), or to display on monitors 17" or larger.
<b>640</b>	640 × 480	Can be displayed full screen on 13" monitors. Suited to distribution by e-mail or the web.

Print sizes assume a printer resolution of approximately 200 dpi.

## Print Size

The size of pictures when printed depends on the resolution of the printer (the higher the resolution, the smaller the final print size).

## Adjusting Exposure: *Exp. +/-*

The **Exp. +/-** (exposure compensation) menu allows you to alter exposure from the value suggested by the camera, making pictures brighter or darker.

At values other than  $\pm 0$ , exposure compensation is shown in the monitor.

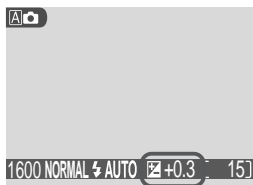

## Keeping Colors True: *White Balance*



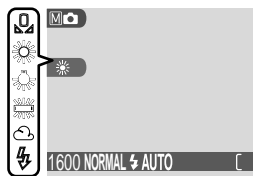



White balance is used to preserve natural colors under different types of lighting. At settings other than **Auto**, the current white balance setting is shown in the monitor.

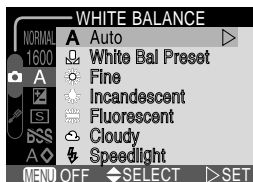

### Choosing a White Balance Setting

In **M** mode, white balance can be chosen from the following options (in **A** and scene modes, white balance is adjusted automatically):



Option	Description
<b>A Auto</b>	White balance automatically adjusted to suit lighting conditions. Best choice in most circumstances.
 <b>White Bal Preset</b>	White object used as reference to set white balance under unusual lighting conditions.
 <b>Fine</b>	White balance adjusted for direct sunlight.
 <b>Incandescent</b>	For use with incandescent lighting.
 <b>Fluorescent</b>	For use with most types of fluorescent lighting.
 <b>Cloudy</b>	Use for pictures taken under cloudy skies.
 <b>Speedlight</b>	White balance adjusted to match light produced by flash.

### Preset White Balance

Preset white balance is used to adjust white balance when shooting under mixed lighting or to compensate for light sources with a strong color cast (for example, to make pictures taken under a lamp with a red shade look as though they had been taken under white light). When  (**White Bal Preset**) is selected from the white-balance menu, the camera will zoom in and the menu shown at right will be displayed in the monitor.





Option	Description
<b>Cancel</b>	Recalls the most recent setting for preset white balance from memory and sets white balance to this value.
<b>Measure</b>	To measure a new value for white balance, place a white object, such as a piece of paper, under the lighting that will be used in the final photograph. Frame this object so that it fills the square in the center of the menu shown above. Highlight <b>Measure</b> and press the multi selector to the right to measure a new value for white balance (shutter will be released and camera will return to original zoom position, but no picture will be recorded).

## Taking Pictures in a Sequence: *Continuous*

The options in the “continuous” menu are used to take pictures in a continuous sequence. This can be useful when, for example, you are trying to capture a fleeting expression on a portrait subject, or photograph a subject that is moving unpredictably. With the **Multi-Shot 16** option, you can record movement in a single picture consisting of sixteen consecutive frames.



Option	Description
 <b>Single</b>	Camera takes one picture each time the shutter-release button is pressed all the way down.
 <b>Continuous</b>	While the shutter-release button is held down, pictures are recorded at a rate of about three frames every two seconds. The camera will continue to take pictures even when the memory buffer (📷 29) is full, although the rate at which pictures are recorded will drop.
 <b>Multi-Shot 16</b>	Each time the shutter-release button is pressed, the camera takes sixteen consecutive “thumbnail” images 400 × 300 pixels in size and combines them into a collage measuring 1,600 × 1,200 pixels. This option is only available when image size (📷 62) is set to <b>1600</b> .

At settings other than **Single**, the current “continuous” setting is indicated by an icon in the monitor.



### Flash, Focus Exposure, and White Balance

At settings of **Continuous** and **Multi-Shot 16**, the flash turns off, and focus distance, exposure, and auto white balance are determined by the first picture in each series.

## Getting Sharper Pictures: *BSS (Best Shot Selector)*

The “Best Shot Selector” (BSS) is recommended for situations in which inadvertent camera movement can produce blurred pictures, for example when:

- the camera is zoomed in
- the flash can not be used although lighting is poor



BSS may not produce the desired results with a moving subject or if you change the composition while the shutter-release button is pressed all the way down.

Option	Description
On	Camera takes photos as long as the shutter-release button is held down, to a maximum of ten. These images are then compared and the sharpest photo (the image with the highest level of detail) saved to the memory card. The flash turns off, and focus distance, exposure, and auto white balance are determined by the first photograph in the series.
Off	BSS off; camera functions normally.

When BSS is on, a **BSS** icon appears in the monitor.







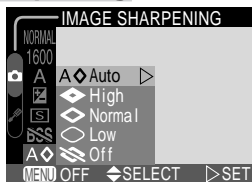

### Restrictions on BSS

BSS is not available at CONTINUOUS settings other than **Single**. Selecting **Continuous** or **Multi-Shot 16** automatically cancels BSS.

## Making Edges More Distinct: *Image Sharpening*

The camera automatically emphasizes the borders between light and dark areas of each picture, making the image seem sharper. The effects are too subtle to be seen in the camera monitor, but are visible when the picture is viewed on a computer monitor or printed. **M** mode gives you control over the amount of sharpening performed (in **A** and scene modes, the camera adjusts sharpening according to the subject).



Option	Description
 <b>Auto</b>	Camera sharpens edges for optimal results; adjustment performed differs from image to image.
 <b>High</b>	Image processed to increase sharpness, making edges more distinct.
 <b>Normal</b>	Camera performs same standard level of sharpening on all images.
 <b>Low</b>	Amount of sharpening reduced below normal level.
 <b>Off</b>	No sharpening performed.

When taking pictures that will later be retouched, choose settings of **Normal** or **Low**.

At settings other than **Auto**, an image-sharpening icon appears in the monitor.

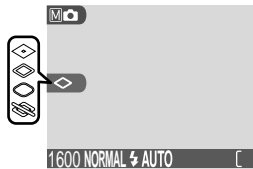





# **Camera Setup**

## *The SET-UP Menu*

---

This chapter details the options available in the SET-UP menu, where you can adjust basic camera settings and perform such tasks as formatting memory cards and restoring settings to their default values.

The SET-UP menu contains options for basic camera setup. The SET-UP menu is accessed from the SHOOTING menu for **A** , **M** , or scene mode (no menu is available in movie mode). To make a selection from the SET-UP menu:

1

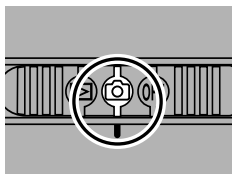

Slide mode selector to

2

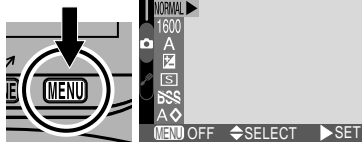

Press MENU button to display menu for current shooting mode

3

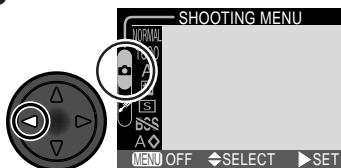

Highlight page tab (selected page tab highlighted in green)

4



Highlight

5

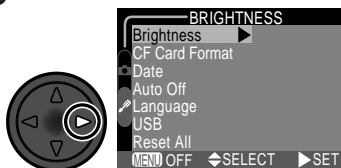

Display SET-UP menu

6

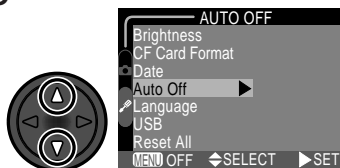

Highlight menu item

7

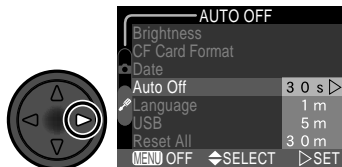

Display options

8

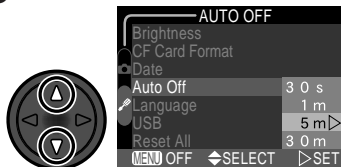

Highlight option  
(to return to previous menu, press multi selector to left)

9

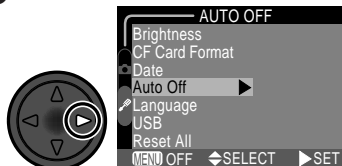



Make selection

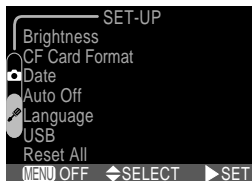

To exit the menu and return to shooting mode, press the **MENU** button.

The SET-UP menu contains the following options:



Option	
Brightness	72
CF Card Format	72
Date	73
Auto Off	73
Language	74
USB	74
Reset All (M  only)	76

## SET-UP Menu Options

The **Brightness** and **CF Card Format** options can also be accessed from the playback menu in  mode ( 85).

## Adjusting Monitor Brightness: *Brightness*

This option controls monitor brightness. Press the multi selector up or down to increase or decrease the brightness of the monitor by moving the arrow to the right of the display up or down.



## Formatting Memory Cards: *CF Card Format*

The memory card provided with your camera is formatted at shipment. If you purchase additional memory cards for added storage, you will however need to format the cards before first use to ensure that they work properly in your camera. Formatting memory cards is also an effective way of deleting all pictures on the card.



Selecting **CF Card Format** from the setup or playback menus displays the confirmation dialog shown above. To format the memory card:

1

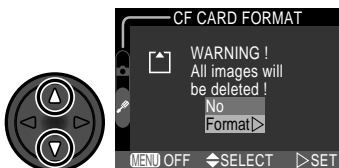

Highlight **Format** (to exit without formatting card, highlight **No** and press multi selector to right)

2



Press multi selector to right to start formatting. *Formatting begins immediately.* While formatting is in progress, the message shown above will be displayed.

### ✓ During Formatting

*Do not remove the memory card, remove the battery, or unplug the AC adapter (available separately) while formatting is in progress.*

## Setting the Time and Date: **Date**

This option is used to set the camera to the current date and time. For more information, see “Tutorial: First Steps” (🔗 22).



## Conserving Battery Power: **Auto Off**

When operated on battery power, the camera will enter sleep mode if no operations are performed for thirty seconds (or three minutes when menus are displayed). The time limit for sleep mode can be chosen from thirty seconds (**30 s**), one minute (**1 m**), five minutes (**5 m**), and thirty minutes (**30 m**) using **Auto Off**.

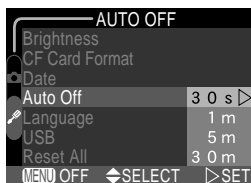

### Before Formatting

*Formatting memory cards permanently deletes all data they contain, including protected pictures and any other data that may be on the card.* Before formatting, be sure to transfer to a computer any pictures you would like to keep.

### Sleep Mode (Auto Off)

In sleep mode, the camera itself is effectively off, consuming almost no power. The camera can be reactivated by pressing the shutter-release button or sliding the mode selector to a new position.

When powered by the EH-60 AC adapter kit (available separately), the camera will remain on for thirty minutes if no operations are performed, regardless of the setting in the **Auto Off** menu.

## Choosing a Language: *Language*

This option is used to choose the language in which camera menus and messages are displayed. For more information, see “Tutorial: First Steps” (📖 20).

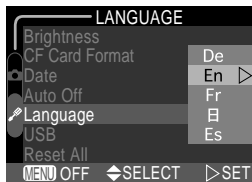

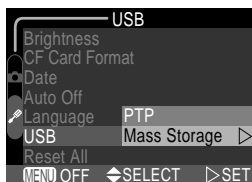

## Choosing a USB Protocol: *USB*

Before pictures can be copied to a computer via direct USB connection (📖 44), you will need to select a USB transfer protocol that matches that used by your computer's operating system. Your camera supports two protocols: PTP (Picture Transfer Protocol) and Mass Storage.



Protocol	Description
PTP	Choose this option when connecting the camera to a computer running Windows XP Home Edition, Windows XP Professional, or Mac OS X (version 10.1.2 or later).
Mass Storage	Choose this option when connecting the camera to a computer running Windows 2000 Professional, Windows Millennium Edition (Me), Windows 98 Second Edition (SE), or Mac OS 9.0, 9.1, or 9.2.

### Mac OS X

Pictures can not be transferred using the camera  (SCENE) button in Mac OS X 10.1.2. Use the  button in Nikon View 5 to transfer pictures. See the *Nikon View 5 Reference Manual* (on CD) for details. The camera  (SCENE) button can be used to transfer images in Mac OS X 10.1.3 or later.

## **Windows 2000 Professional, Windows Millennium Edition (Me), Windows 98 Second Edition (SE), Mac OS 9**

Do *not* select **PTP** when connecting the COOLPIX 2500 to a computer running one of the above operating systems (there is no need to change the USB setting when using the camera for the first time, as **Mass Storage** is selected at shipment).

If you have already changed the USB setting to **PTP**, be sure to select **Mass Storage** before connecting the camera to your computer.

If you have connected the camera to a computer running one of the above operating systems with **PTP** selected in the **USB** menu, disconnect the camera as described below. Be sure to select **Mass Storage** in the **USB** menu before reconnecting the camera.

### *Windows 2000 Professional*

A dialog will be displayed welcoming you to the Found New Hardware Wizard. Click **Cancel** to close the dialog, and then disconnect the camera.

### *Windows Millennium Edition (Me)*

After displaying a message stating that the hardware information database is being updated, the computer will start the Add New Hardware Wizard. Click **Cancel** to exit the wizard, and then disconnect the camera.

### *Windows 98 Second Edition (SE)*

The Add New Hardware Wizard will be displayed. Click **Cancel** to exit the wizard, and then disconnect the camera.

### *Mac OS 9*

A dialog will be displayed stating that the computer is unable to use the driver needed for the "Nikon Digital Camera E2500\_PTP" USB device. Click **Cancel** to close the dialog, and then disconnect the camera.

## Restoring Default Settings: *Reset All* (M Mode Only)

**Reset All** is used to reset settings to their default values. This option is only available in the SET-UP menu for **M** mode, but resets settings for all modes.

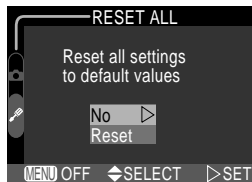

Option	Description
<b>No</b>	Exit menu, leaving settings unchanged.
<b>Reset</b>	Restore settings to default values.

Choosing **Reset** restores the settings listed below to their default values.

Setting	Default
White balance	Auto
Exposure compensation	±0
Continuous	Single
Best Shot Selector	Off

Setting	Default
Image sharpening	Auto
Monitor brightness	3
Auto off	30 s

Choosing **Reset** also clears the current file number (F 49) from memory. Numbering will continue from the lowest number available on the memory card. All other settings are unaffected.



### Resetting File Numbering to 0001

To reset file numbering (F 49) to 0001, select **Reset All** after either deleting all pictures (F 87) or formatting the memory card (F 72).



# Playing Pictures Back

*Playback Mode*

Basic Playback



78–84



The Playback Menu



85–91



This section details the operations that can be performed when the mode selector is set to . It is divided into the following two sections:

















## *Basic Playback*

This section covers playback operations that can be performed using the buttons on the back of the camera and the multi selector.

## *The Playback Menu*

Read this section for a description of the operations that can be performed in the playback menu.





To	Press	Description
Zoom photo in		Press the <b>Q</b> (  ) button for an enlarged view of the current photo (  81).
Select current picture for transfer to a computer	 ( <b>SCENE</b> )	Pictures selected for transfer are marked with a  icon. Turn this marking on or off to select the pictures that will be transferred to a computer at a later date (  44).
Create small copy of current picture	<b>SMALL PIC.</b> ( <b>QUICK</b>  )	If the current picture is a photograph, pressing the <b>QUICK</b>  button will create a small copy (320 × 240) for electronic distribution (  82).
Play movie back	<b>QUICK</b> 	If the current picture is marked with a  icon to show that it is a movie, pressing the <b>QUICK</b>  button starts and pauses movie playback (  84).
Hide or display photo info		Press multi selector to left to hide or display photo info superimposed on picture in monitor (  7).
Display playback menu	<b>MENU</b>	Press the <b>MENU</b> button to display or hide the playback menu (  85).









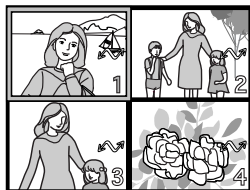







## Image File and Folder Names

Pictures taken with the COOLPIX 2500 are identified by file names that begin with “DSCN” or, in the case of pictures created with the small picture function ( 82), “SSCN,” followed by a four-digit file number assigned automatically by the camera. Each file name ends in a three-letter “extension” that identifies the type of picture: “.JPG” for photographs and “.MOV” for movies. Picture files are stored in folders created automatically by the camera and named with a three digit folder number followed by “NIKON” (e.g., “100NIKON”).

## Thumbnail Review

Pressing the  () button in full-screen review displays a menu of four thumbnail images. The following operations can be performed while thumbnails are displayed:



To	Press	Description
Highlight pictures		Press the multi selector up, down, left, or right to highlight thumbnails.
Change number of pictures displayed	 (  )  (  )	With four thumbnails displayed, press the  button once to view nine thumbnail images. Press  (  ) to “zoom in” from nine thumbnails to a four-thumbnail view or, when four thumbnails are displayed, to view highlighted picture full size.
Delete highlighted picture		A confirmation dialog will be displayed. Press multi selector up or down to highlight option, press to right to select. <div data-bbox="387 851 646 1033" style="border: 1px solid black; padding: 5px; margin: 10px 0;"> <p style="text-align: center;">DELETE</p> <p style="text-align: center;"> ERASE IMAGES YES OR NO ?</p> <p style="text-align: center;">No &gt;</p> <p style="text-align: center;">Yes</p> <p style="text-align: center;">◀SELECT      SET▶</p> </div> <ul style="list-style-type: none"> <li>• Select <b>No</b> to exit without deleting picture</li> <li>• Select <b>Yes</b> to delete picture</li> </ul>
Select highlighted picture for transfer to a computer	 (  )	Pictures selected for transfer are marked with a  icon. Turn this marking on or off to select the pictures that will be transferred to a computer at a later date (  44).
Create small copy of highlighted picture	<b>SMALL PIC.</b> (  )	If the current picture is a photograph, pressing the  button will create a small copy for electronic distribution (  82).



## Creating a Small Copy of a Picture: Small Picture

Pressing the **SMALL PIC.** (**QUICK**) button in full-frame or thumbnail playback creates a small copy of the current picture. Copies are 320 × 240 pixels in size and have an image quality of BASIC, making them ideal for distribution by e-mail or for use in web pages.

To create a small copy of the picture currently displayed in full-frame playback, or the picture highlighted in thumbnail playback:

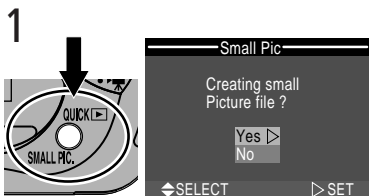

Press **SMALL PIC.** (**QUICK**) button to display confirmation dialog

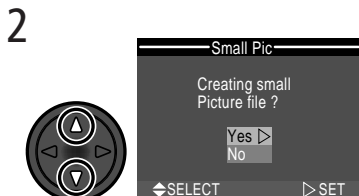

Highlight **Yes** (to exit without creating copy, highlight **No** and press multi selector to right)

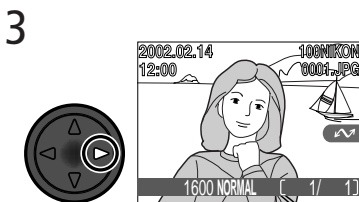

Create small copy and return to playback mode with original picture displayed

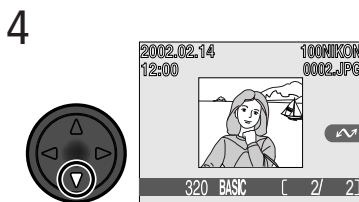



To view copy, press multi selector down. Copy will have same time and date of creation as original.

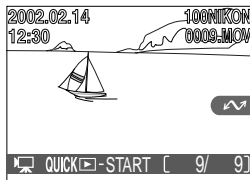

## Movie Playback

Movies are indicated by a  icon. In full-frame playback, movies can be viewed using the **QUICK▶** button. Movies can not be played back when thumbnails are displayed.



To	Press	Description
Start playback	<b>QUICK▶</b>	When movie ends, final frame is displayed for one second, followed by a still image of the first frame.
Pause/resume playback	<b>QUICK▶</b>	Pressing the <b>QUICK▶</b> button while playback is in progress pauses display. To resume playback, press the <b>QUICK▶</b> button again.
Rewind movie one frame		When movie is paused, pressing the multi selector up rewinds the movie one frame.
Advance movie one frame		When movie is paused, pressing the multi selector down advances the movie one frame. If the last frame of the movie is displayed, pressing the multi selector down ends movie playback and displays the first frame of the movie.

## Inverted Playback

Movies recorded with the lens pointing in the same direction as the monitor will be played back upside down.



# The Playback Menu

Managing Pictures

The playback menu contains options for deleting pictures and protecting images from deletion. You can also create a digital “print order” for printing photographs on any device compatible with the Digital Print Order Format (DPOF), and select images for transfer to a computer.

To view the playback menu:

1

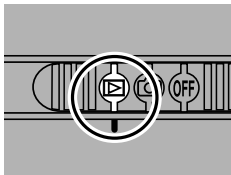

Select 

2

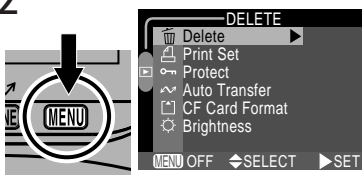



Press MENU button to display playback menu

The playback menu contains the following options:



Option	
Delete	86–87
Print Set	88–89
Protect	90
Auto Transfer	91
CF Card Format	72
Brightness	72

## Memory Card Format/Brightness

The **CF Card Format** and **Brightness** options can also be accessed from the SET-UP menu for  mode. These options are described in “Camera Setup” ( 69).

## Deleting Pictures: *Delete*

The **Delete** menu contains the following options:

Option	Description
<b>Selected Images</b>	Delete selected photographs and movies.
<b>All Images</b>	Delete all pictures.

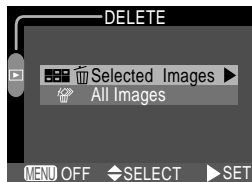

## Deleting Selected Photographs and Movies

To delete selected photographs and movies:

1



Highlight **Selected Images**

2

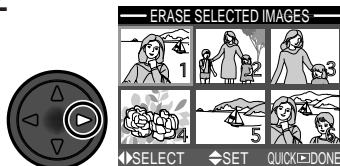

Display menu of thumbnail images

3

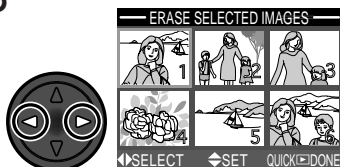

Highlight picture

4

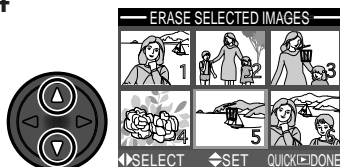

Press multi selector up or down to select picture for deletion. Selected pictures are marked by  icon. Repeat steps 3 and 4 to select additional pictures for deletion. To deselect picture, highlight and press multi selector up or down. To exit without deleting pictures, press MENU button.



## Ordering Prints: *Print Set*

Selecting **Print Set** from the playback menu displays the menu shown at right. Using the **Print set** option, you can specify the pictures to be printed, the number of prints, and the information to be included on each print. This information is stored on the memory card in Digital Print Order Format (DPOF). Once a print order has been created, the memory card can be removed from the camera and inserted in any DPOF-compatible device—be it your personal photo printer or a photofinisher's print system—and pictures printed directly from the card.



Option	Description
<b>Print set</b>	Create or modify print order.
<b>Delete print set</b>	Cancel the current print order.

## Selecting Pictures for Printing

To create a print order, or to modify the existing print order, highlight **Print set** in the print set menu and press the multi selector to the right. The menu shown at right will be displayed. To select pictures for printing:

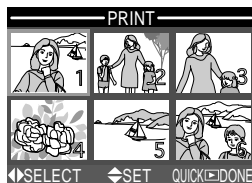

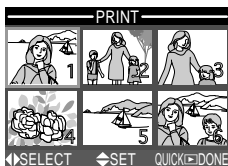

1

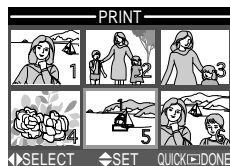

Highlight pictures

2



Press multi selector up to select picture. Selected pictures are marked by  icon.



## Safeguarding Valuable Pictures: *Protect*

Selecting **Protect** from the playback menu displays the menu shown at right, where you can select pictures to protect from accidental deletion.

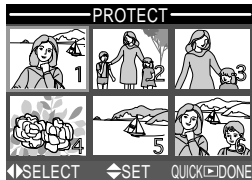

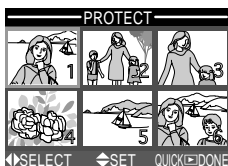

1

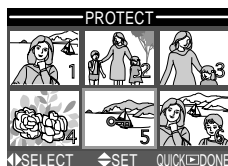

Highlight picture

2



Press multi selector up or down to select picture. Selected pictures are marked by  icon. Repeat steps 1 and 2 to select additional pictures. To deselect picture, highlight and press multi selector up or down.

3

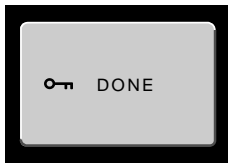

Press **QUICK=** to complete operation. To exit **Protect** menu without changing protected status of pictures, press **MENU** button.

### Protected Pictures

Protected files can not be deleted in review, single-image playback, or from the **Delete** sub-menu. Note, however, that protected pictures *will* be deleted when the memory card is formatted.

## Marking All Pictures for Transfer: *Auto Transfer*

To turn transfer marking (📷 44) on or off for all pictures simultaneously, select **Auto Transfer** from the playback menu. The following options will be displayed:



Option	Description
<b>All ON</b>	Mark all pictures on the memory card for transfer to a computer.
<b>All OFF</b>	Remove transfer marking from all pictures on the memory card.

### Transferring More than 999 Pictures

No more than 999 pictures can be transferred at one time using the  (SCENE) button (📷 44). To copy more pictures, use Nikon View 5. See the *Nikon View 5 Reference Manual* (on CD) for details.

### Marking Pictures for Transfer with Other Cameras

Pictures selected for transfer with another model of Nikon digital camera can not be transferred when the memory card is inserted in the COOLPIX 2500. Use the COOLPIX 2500 to reselect the images.







# **Technical Notes**

*Camera Care, Options, and Resources*

---

This chapter provides tips on cleaning and storing your camera, a list of optional accessories available for the COOLPIX 2500, information on where to get help on line, troubleshooting advice, and camera specifications.

## Caring for Your Camera

### Cleaning

#### *Lens*

One key to cleaning the lens is to not touch it with your fingers. Use a *blower* (typically a small device with a rubber bulb attached to one end that you pump to produce a stream of air out the other) to remove dust or lint. To remove fingerprints or other stains that can not be removed with a blower, wipe the lens with a soft cloth, using a spiral motion that starts in the center of the lens and works out to the edges.

#### *Monitor*

Remove dust or lint with a blower. To remove fingerprints and other stains, clean the monitor with a soft, dry cloth, being careful not to apply pressure.

#### *Body*

Use a blower to remove dust and lint, then wipe gently with a soft, dry cloth. After using the camera at the beach or seaside, wipe off any sand or salt with a cloth lightly dampened with fresh water, then dry thoroughly.

*Do not use alcohol, thinner, or other volatile chemicals*

### Storage

When the camera will not be used for an extended period, remove the battery after checking to make sure that the camera is off and the lens housed inside the camera body. Do not store your camera in locations that:

- are poorly ventilated or damp
- are next to equipment that produces strong electromagnetic fields, such as televisions or radios
- are exposed to temperatures above 50 °C (122 °F) or below -10 °C (14 °F)
- are subject to humidities of over 60%

## Optional Accessories

At the time of writing, the following optional accessories were available for the COOLPIX 2500. Contact your retailer or local Nikon representative for details.

<b>Rechargeable battery</b>	Additional EN-EL2 Li-ion batteries are available from your retailer or local Nikon representative
<b>AC adapter</b>	EH-60 AC adapter kit
<b>Carrying case</b>	CS-E2500 soft case
<b>CompactFlash™ memory card adapters</b>	EC-AD1 PC-card adapter
<b>Monitor (LCD) hood</b>	HL-E2500 LCD hood

## Approved Memory Cards

The following memory cards have been tested and approved for use in the COOLPIX 2500:

<i>SanDisk</i>	SDCFB series	16 MB, 32 MB, 48 MB, 64 MB, 96 MB, 128 MB
<i>Lexar Media</i>	4× USB series	8 MB, 16 MB, 32 MB, 48 MB, 64 MB, 80 MB
	8× USB series	8 MB, 16 MB, 32 MB, 48 MB, 64 MB, 80 MB
	10× USB series	128 MB, 160 MB

Operation is not guaranteed with other makes of memory card. For more details on the above cards, please contact the manufacturer.

## Web Resources

At the time of writing, the following on-line resources were available for users of Nikon digital imaging equipment:

### For Product Information and Tips

- For users in the USA: <http://www.nikonusa.com/>
- For users in Europe: <http://www.nikon-euro.com/>
- For users in Asia, Oceania, the Middle East, and Africa:  
<http://www.nikon-asia.com/>

### For Contact Information



Contact information for the Nikon representative in your area may be found at:  
<http://www.nikon-image.com/eng/>



## Troubleshooting

If your camera fails to function as expected, check the list of common problems below before consulting your retailer or Nikon representative. Refer to the page numbers listed in the rightmost column for information on solving the problems listed here.

Problem	Possible cause	
Monitor is blank	• Camera is off.	6
	• Battery is not correctly inserted.	17
	• Battery is exhausted.	19
	• EH-60 AC adapter kit (available separately) is not properly connected.	—
	• Camera is in sleep mode. Press shutter-release button halfway.	73
	• USB cable is connected.	45
Camera turns off immediately	• Battery is low. • Battery is cold.	19 v
No indicators appear in monitor	• Indicators are hidden. Press multi selector to left until indicators are displayed.	7







Problem	Possible cause	
Monitor is hard to read	<ul style="list-style-type: none"> <li>• Ambient lighting is too bright: move to a darker location or use HL-E2500 LCD hood (available separately).</li> </ul>	95
	<ul style="list-style-type: none"> <li>• Monitor is dirty.</li> </ul>	94
	<ul style="list-style-type: none"> <li>• Monitor brightness requires adjustment.</li> </ul>	72
No photo is taken when shutter-release button is fully pressed	<ul style="list-style-type: none"> <li>• Camera is in playback mode.</li> </ul>	6
	<ul style="list-style-type: none"> <li>• Battery is exhausted.</li> </ul>	19
	<ul style="list-style-type: none"> <li>• Message "Please turn the lens to the shooting position" appears in monitor: lens is blocked by camera body. Rotate lens section until message is no longer displayed.</li> </ul>	26
	<ul style="list-style-type: none"> <li>• Message "OUT OF MEMORY" appears in monitor: insufficient memory to record pictures at current settings.</li> </ul>	101
	<ul style="list-style-type: none"> <li>• Focus indicator flashes red: camera unable to focus.</li> </ul>	28
	<ul style="list-style-type: none"> <li>• Flash-ready lamp flickers: flash is charging.</li> </ul>	28
Photos are too dark (underexposed)	<ul style="list-style-type: none"> <li>• Message "CARD IS NOT FORMATTED" appears in monitor: memory card is not formatted for use in COOLPIX 2500.</li> </ul>	101
	<ul style="list-style-type: none"> <li>• Message "NO CARD PRESENT" appears in monitor: no memory card in camera.</li> </ul>	16
	<ul style="list-style-type: none"> <li>• Flash is off.</li> </ul>	53
	<ul style="list-style-type: none"> <li>• Flash window is blocked.</li> </ul>	27
Photos are too bright (overexposed)	<ul style="list-style-type: none"> <li>• Subject is outside range of flash.</li> </ul>	104
	<ul style="list-style-type: none"> <li>• Exposure compensation is too low.</li> </ul>	63
Photos are out of focus	<ul style="list-style-type: none"> <li>• Exposure compensation is too high.</li> </ul>	63
	<ul style="list-style-type: none"> <li>• Focus indicator flashes red: camera unable to focus.</li> </ul>	28

Problem	Possible cause	
Photos are blurred	<ul style="list-style-type: none"> <li>• Camera shook during shot. Blurring caused by camera shake can be reduced by:                             <ul style="list-style-type: none"> <li>– Using the flash</li> <li>– Using the Best-Shot Selector (BSS)</li> <li>– Using the self-timer</li> <li>– Using a tripod</li> </ul> </li> </ul>	53 67 55 —
Randomly-spaced bright pixels (“noise”) appear in image	<ul style="list-style-type: none"> <li>• Shutter speed too slow. Use the flash.</li> <li>• Noise reduction, which helps reduce noise at slow shutter speeds, is available in the following scenes: <b>Night Portrait</b> and <b>Night Landscape</b>. Using these scenes when appropriate can reduce noise.</li> </ul>	53 38, 39
Flash does not fire	<ul style="list-style-type: none"> <li>• Flash is off. Note that flash turns off automatically when:                             <ul style="list-style-type: none"> <li>– <b>Landscape, Sunset, Night Landscape, Museum, or Fireworks Show</b> is selected in scene mode</li> <li>– Camera is in movie mode</li> <li>– <b>Continuous</b> or <b>Multi-Shot 16</b> is selected in the CONTINUOUS menu (M  mode only)</li> <li>– BSS is on (M  mode only)</li> </ul> </li> <li>• Battery level is low.</li> </ul>	53 38, 39 52 66 67 19
Colors are unnatural	<ul style="list-style-type: none"> <li>• White balance does not match light source.</li> </ul>	64
No menu is displayed when <b>MENU</b> button is pressed	<ul style="list-style-type: none"> <li>• Camera is in movie mode.</li> </ul>	52









Problem	Possible cause	
Picture can not be played back	<ul style="list-style-type: none"> <li>Picture has been overwritten or renamed by a computer or other make of camera.</li> </ul>	—
Pressing <b>QUICK</b>  button when picture is displayed full screen does not create small picture	<ul style="list-style-type: none"> <li>Picture is displayed in full-screen review. Small pictures can only be created in playback mode.</li> </ul>	82
	<ul style="list-style-type: none"> <li>Picture is a movie. Small pictures can only be created from photos.</li> </ul>	82
	<ul style="list-style-type: none"> <li>Picture is already a small picture.</li> </ul>	83
	<ul style="list-style-type: none"> <li>There is not enough free space on the memory card for a small picture.</li> </ul>	83
Can not zoom in on picture during playback or review	<ul style="list-style-type: none"> <li>Picture is a movie.</li> <li>Picture was created using small picture option.</li> </ul>	81
Nikon View 5 does not start when camera connected or memory card inserted in card reader or card slot	<ul style="list-style-type: none"> <li>Camera is off.</li> </ul>	6
	<ul style="list-style-type: none"> <li>EH-60 AC adapter kit (available separately) is not properly connected, or battery is dead.</li> </ul>	—
	<ul style="list-style-type: none"> <li>USB cable not correctly connected, or card not properly inserted in card reader, card adapter, or card slot.</li> </ul>	45, 48
	<ul style="list-style-type: none"> <li><b>USB</b> item in setup menu set to <b>PTP</b> when camera connected to computer running Windows 2000 Professional, Windows Millennium Edition (Me), Windows 98 Second Edition (SE), or Mac OS 9</li> <li>Camera is not registered in Device Manager (Windows only).</li> </ul>	74
<p>See <i>Nikon View 5 Reference Manual</i> (on CD) for further information on troubleshooting Nikon View 5.</p>	—	

## Error Messages

The following table lists the error messages and other warnings that appear in the monitor and how to deal with them.

Display	Problem	Solution	
 (Flashes)	Clock calendar not set.	Set clock calendar to current date and time.	22–23
WARNING !! BATTERY EXHAUSTED	Battery exhausted.	Turn camera off and replace battery.	19
<b>AF</b> (● flashes red)	Camera cannot focus.	Use focus lock to focus on another subject at same distance, then recompose photograph.	28
	Slow shutter speed. Photos may be blurred.	Use flash, or steady camera by mounting on tripod, placing on level surface, or holding in both hands with elbows against torso.	37, 53
Please turn the lens to the shooting position	Lens is blocked by camera body.	Rotate lens until message is no longer displayed.	26
 WARNING !! Please wait for camera to finish recording	Camera turned off or playback mode selected while pictures are being saved.	Message clears from display automatically when recording is complete.	29
 NO CARD PRESENT	Camera can not detect memory card.	Turn camera off and confirm that memory card is correctly inserted.	16
 CARD IS NOT FORMATTED FORMAT NO 	Memory card has not been formatted for use in COOLPIX 2500.	Press multi selector up to highlight <b>FORMAT</b> and press to right to format card, or turn camera off and replace card.	16



Display	Problem	Solution	
 THIS CARD CANNOT BE USED	Error accessing memory card.	<ul style="list-style-type: none"> <li>• Use approved card.</li> <li>• Check that connectors are clean. If card is damaged, contact retailer or Nikon representative.</li> </ul>	95
 THIS CARD IS INCOMPATIBLE			—
 OUT OF MEMORY	<i>Camera in  mode:</i> Insufficient memory to record pictures at current settings.	<ul style="list-style-type: none"> <li>• Reduce image quality or size.</li> <li>• Delete photographs.</li> <li>• Insert new memory card.</li> </ul>	61, 62, 86, 16
	<i>Error occurs when you try to transfer images to computer.</i> Not enough space on memory card to record information needed for transfer.	Disconnect camera, delete unwanted photographs and try again.	86
 IMAGE CANNOT BE SAVED	<ul style="list-style-type: none"> <li>• Memory card has not been formatted for use in camera, or error occurred while saving photo.</li> <li>• Camera has run out of file numbers.</li> </ul>	<ul style="list-style-type: none"> <li>• Reformat memory card.</li> <li>• Insert new memory card or delete pictures.</li> </ul>	72, 16, 86
CARD CONTAINS NO IMAGES	No pictures on memory card.	<ul style="list-style-type: none"> <li>• Camera in review mode: half-press shutter button to return to  mode.</li> <li>• Camera in  mode: select  mode.</li> </ul>	33
			6



Display	Problem	Solution	
COMMUNICATIONS ERROR	USB cable disconnected or memory card removed while pictures are being transferred to computer.	If error appears in computer monitor, click <b>OK</b> to exit Nikon View 5. Turn camera off, reconnect cable or replace memory card, then turn camera on.	16, 44, 47
	Protocol selected in <b>USB</b> menu does not match that used by computer operating system, causing error when  ( <b>SCENE</b> ) button is pressed to transfer pictures.	Turn camera off and disconnect USB cable, then change <b>USB</b> selection in camera setup menu and reconnect camera. If error reoccurs, use Nikon View 5  button to transfer pictures.	74
FILE CONTAINS NO IMAGE DATA	File created by computer or different make of camera.	Delete file or reformat memory card.	86, 72
NO IMAGES ARE MARKED FOR TRANSFER	No pictures marked for transfer when  ( <b>SCENE</b> ) button pressed to copy pictures to computer.	Disconnect camera and mark at least one picture for transfer before connecting camera again.	33, 44, 79, 91
TRANSFER ERROR	Error occurred when pictures were transferred to computer.	Check that the camera is properly connected and battery fully charged.	44, 19
SYSTEM ERROR	Error has occurred in camera's internal circuitry.	Turn camera off, unplug optional AC adapter kit (if using) or remove and re-insert battery, and turn camera on. If error persists, contact retailer or Nikon representative.	16



## Specifications

Type	E2500 digital camera
Effective pixels	2.0 million
CCD	$\frac{1}{2.7}$ " high-density CCD; total pixels: 2.11 million
Image size (pixels)	<ul style="list-style-type: none"><li>• 1600 × 1200 (1600)</li><li>• 1024 × 768 (1024)</li><li>• 1280 × 960 (1280)</li><li>• 640 × 480 (640)</li></ul>
Lens	3 × Zoom Nikkor
Focal length	F = 5.6 – 16.8 mm (35-mm [135] camera format equivalent: 37 – 111 mm)
f/-number	f/2.7 – f/4.8
Construction	Seven elements in six groups
Digital zoom	4.0 ×
Autofocus (AF)	Contrast-detect through-the-lens (TTL) AF
Focus range	30 cm (1') – ∞; 4 cm (1.6") – ∞ in <b>Close Up</b> mode
Focus-area selection	Five-area multi AF with auto AF-area selection
Monitor	1.5", 110,000-dot, low temperature polysilicon TFT LCD with brightness adjustment
Frame coverage (📷 mode)	Approximately 97% vertical and 97% horizontal
Storage	
Media	Type I CompactFlash™ (CF) cards
File system	Compliant with Design rule for Camera File systems (DCF), Exif 2.2, and Digital Print Order Format (DPOF)
Compression	JPEG-baseline-compliant
Exposure	
Metering	256-segment matrix metering
Exposure control	Programmed auto exposure with exposure compensation (–2.0 – +2.0 EV in steps of $\frac{1}{3}$ EV)
Range (ISO 100 equivalent)	W: 1.9 – 15.9 EV T: 3.5 – 17.6 EV

<b>Shutter</b>	Mechanical and charge-coupled electronic shutter
<b>Speed</b>	$2 - \frac{1}{3000} \text{ s}$
<b>Aperture</b>	Electronically-controlled preset aperture
<b>Range</b>	Two steps (f/2.7 and f/4.5 [W])
<b>Sensitivity</b>	Approximately equivalent to ISO 100 (auto gain to ISO 400 equivalent)
<b>Self-timer</b>	Ten-second duration
<b>Built-in Speedlight</b>	
<b>Range</b>	0.4 – 3.0 m (1'4" – 9'10") (W) 0.4 – 1.7 m (1'4" – 5'7") (T)
<b>Flash control</b>	Sensor flash system
<b>Interface</b>	USB
<b>Power sources</b>	<ul style="list-style-type: none"> <li>• One rechargeable Nikon EN-EL2 lithium-ion battery (supplied)</li> <li>• EH-60 AC adapter kit (available separately)</li> </ul>
<b>Battery life (EN-EL2)</b>	Approximately 80 minutes with fully-charged battery (measured at room temperature [20 °C/68 °F] under standard Nikon test conditions: zoom adjusted with each shot, flash used in approximately one third of photographs, image quality set to NORMAL)
<b>Dimensions (W × H × D)</b>	114 × 59.5 × 31.5 mm (4.5" × 2.3" × 1.2")
<b>Weight</b>	Approximately 175 g (6.2 oz) without battery or memory card
<b>Operating Environment</b>	
<b>Temperature</b>	0 – 40 °C (32 – 104 °F)
<b>Humidity</b>	Less than 85% (no condensation)



### Design Rule for Camera File Systems (DCF)

Your camera names pictures according to the Design Rule for Camera File Systems (DCF), a standard widely used in the digital camera industry to ensure compatibility among different makes of camera.

**System requirements (Nikon View 5): Windows**

<b>OS</b>	Pre-installed versions of Windows XP Home Edition, Windows XP Professional, Windows 2000 Professional, Windows Millennium Edition (Me), Windows 98 Second Edition (SE)
<b>Models</b>	Only models with built-in USB ports supported
<b>CPU</b>	300 MHz Pentium or better
<b>RAM</b>	64 MB or more recommended
<b>Hard-disk space</b>	25 MB required for installation, with additional free disk space of 10 MB plus double the capacity of camera memory card available on system disk when Nikon View 5 is running.
<b>Video resolution</b>	800 × 600 or better with High Color (True Color recommended)
<b>Miscellaneous</b>	CD-ROM drive required for installation

**System requirements (Nikon View 5): Macintosh**

<b>OS</b>	Mac OS 9.0, Mac OS 9.1, Mac OS 9.2, Mac OS X (10.1.2 or later)
<b>Models</b>	iMac, iMac DV, Power Mac G3 (Blue & White), Power Mac G4 or later, iBook, PowerBook G3 or later; only models with built-in USB ports supported
<b>RAM</b>	64 MB or more recommended
<b>Hard-disk space</b>	25 MB required for installation, with additional free disk space of 10 MB plus double the capacity of camera memory card available on start-up disk when Nikon View 5 is running.
<b>Video resolution</b>	800 × 600 or better with thousands of colors (millions of colors recommended)
<b>Miscellaneous</b>	CD-ROM drive required for installation

## Symbols

**1600, 1280, 1024, 640**, 62

 (shooting) mode, 6

 (playback) mode, 6

 button, 4, 33, 34, 78, 80

 button, 4, 33, 79, 81

 button, 5, 53

 button, 5, 33, 34, 78, 80

 button, 5, 33, 34, 79, 80  
See shooting mode; movies

, See self timer

, 6, 19

, 6, 23

, 6, 37, 54







       37–40

 **AUTO**,   , 53

, 6, 63



**A**,      , 64

     , 66

     , 68

    , 88, 90, 91

**A**

 . See shooting mode, auto

Accessories. See optional accessories

AF●. See focus indicator

Autofocus, 28

**Auto Off**, 73

**Auto Transfer**, 91

**B**

**Back Light**, 40

BASIC, 61

Battery, 16–17, 19

life, 104

storing, v

**Beach/Snow**, 38

BEST SHOT SELECTOR, 67

**Brightness**, 72

BSS. See BEST SHOT SELECTOR

**C**

Camera strap, 16

CF card. See memory card

**CF Card Format**, 72

Clock-calendar, 19

**Close Up**, 40

CompactFlash™ card. See memory card

Compression. See image quality

Computer. See Nikon View 5; transfer

CONTINUOUS, 66

**Copy**, 40

Copying images. See transfer

**D**

**Date**, 22–23

DCF. See Design rule for Camera File systems

**Delete**, 86–87

Deleting images

from playback menu, 86–87

in full-frame playback, 78

in quick review, 33

in thumbnail review, 34, 80

Design rule for Camera File systems, 49

Digital Print Order Format, 88

**DISP**. See monitor, indicators; photo information

DPOF. See digital Print Order Format

**E**

Error messages, 100–102

EXP +/-, 63

Exposure compensation, 6, 63

**F**

FINE, 61

**Fireworks Show**, 39

Flash, 53

Flash mode, 53

Flash-ready lamp, 28, 53

Focus. See autofocus

Focus indicator, 6, 28

Formatting. See memory card

**I**

Image quality, 6, 61

Image size, 6, 62

IMAGE SHARPENING, 68

ISO. See sensitivity

**J**



JPEG. See image quality

**L**

**Landscape**, 38

**Language**, 20–21, 74

**M**

 . See shooting mode, manual

Mass storage. See USB.

Memory card, v

approved cards, 95

capacity of, 61

formatting, 72

insertion and removal of, 16–17

reading pictures from, 48–49

**MENU** button, 4, 59, 70, 85

Menus, 9–14

Mode selector, 5, 6

Monitor, 5, 6–7

brightness, 72

indicators, 6–7

framing photographs in, 27

MOV. See movies

Movies, 52

playing back, 84

recording, 52

Multi selector, 5, 8

**Museum**, 39

**N**

**Night Landscape**, 39

**Night Portrait**, 38

Nikon View 5, i, 42

system requirements for, 105

Noise, 38, 54

Noise reduction, 38

NORMAL, 61

Number of exposures remaining, 6, 25

## O

On/off. See mode selector

Optional accessories, 95

## P

**Party/Indoor**, 37

Photo information, 7, 33, 79

Picture Transfer Protocol. See USB.

Playback, 78. See also quick review

full frame, 78

movie, 84

thumbnail, 80

zoom, 81

PLAY BACK menu, 85

**Portrait**, 37

**Print Set**, 88–89

**Protect**, 90

PTP. See USB.

## Q

Quality. See image quality

**QUICK**  button, 5, 31

Quick review, 32

full screen, 32

thumbnail, 34

QuickTime. See movies

QVGA. See movies

## R

Red-eye reduction. See flash mode

**Reset All**, 76

## S

Scene, 36

mode, 37–40

selection, 36

**SCENE** button, 5

Self-portrait. See monitor; self-timer



Self-timer, 55

Sensitivity, 6, 54

SET-UP menu, 69

Sharpening. See IMAGE SHARPENING

Shooting mode, 6, 52

  (auto), 52

  (manual), 52

movie, 52

Shutter-release button, 28–29

Shutter release delay. See self-timer

Size. See image size

**SMALL PIC.** button, 4, 82

Small picture, 82

Smear, v

Specifications, 103

Speedlight. See flash

Strap. See camera strap

**Sunset**, 39

## T

**T.** See zoom, indicator

. See zoom, buttons

Telephoto. See zoom

Thumbnail display, 34, 80

Time and date. See **Date**

Timer. See self-timer

Transfer, 42–49

marking images for, 33, 34, 79, 80, 91

Troubleshooting, 96–102

## U

USB, 46, 74. See also transfer

## W

**W.** See zoom, indicator

. See zoom, buttons

Web resources, 96

White balance, 64

preset, 65

Wide angle. See zoom

## Z

Zoom

buttons, 4, 27, 57

digital, 57

indicator, 27, 57

optical, 57

***Nikon***

**NIKON CORPORATION**  
Fuji Bldg., 2-3 Marunouchi 3-chome,  
Chiyoda-ku, Tokyo 100-8331, Japan

Printed in Japan  
S2C05000401(11)  
*6MAA1511-04*